



P.N.:6530-395B Rev. B

880 SERIES OWNER'S MANUAL

Maxxus™ | Aspen® | Optima® | Cameo® | Majesta® | Altamar™ | Marin™ | Capri®

Sundance® Spas

Attention New Hot Tub Owner!

Congratulations on the purchase of your new Sundance® hot tub! The following is a list of automated functions performed by your hot tub. These functions are listed below in an attempt to suppress any operational concerns you may have during the first 24 hours of ownership! Also listed below are important maintenance recommendations you should observe on a regular basis to protect your new investment.

Automated Spa Operations

Your new hot tub is equipped with an automated “blow-out” cycle that clears all plumbing lines daily to promote maximum water sanitation. Each day at 12:00 PM (noon), pump 2, pump 3 (Maxxus™/Aspen® Models) and the blower will automatically turn on for a period of one minute, then go off. Then pump 1 will turn on and run for one minute to complete the blow-out cycle. Be aware, the factory programmed blow-out cycle cannot be canceled or altered!

Maintain Healthy Spa Water

Always maintain your hot tub’s water chemistry within the following parameters:

	With CLEARRAY®	Without CLEARRAY®
pH	7.4-7.6	7.4-7.6
Free chlorine	no less than 1.0 ppm	3.0-4.0 ppm
Free Bromine	no less than 2.0 ppm	2.0-4.0 ppm
Total Alkalinity	100-150 ppm	100-150 ppm
Calcium Hardness	150-250 ppm	150-250 ppm

IMPORTANT: CLEARRAY® Water Purification System is factory installed. If the CLEARRAY® system is altered or is not operating efficiently follow the “without CLEARRAY®” water chemistry parameters. Such parameters are defined by the Association of Pool and Spa Professionals. CLEARRAY® requires an annual lamp replacement to properly sanitize your water.

 **TO DECREASE RISK OF INFECTION OR DISEASE!** Always maintain your spa filter as outlined below to ensure healthy spa water. Refer to pages 60-62 for additional information.

Required Filter Maintenance

Your new hot tub is equipped with an advanced MICROCLEAN® Ultra water filtration system that provides unsurpassed water quality! To ensure maximum water quality at all times, you should replace the filter cartridge every six months, or earlier as necessary. The filter cartridge is designed to be thrown away! Attempts to reuse the filter cartridge may result in the re-release of unwanted particles back into the hot tub. See pages 60-62 for detailed filter cartridge replacement instructions.

Required Water Replacement

 **TO DECREASE RISK OF INFECTION OR DISEASE!** You should replace the hot tub’s water every 3 to 6 months. The frequency depends on a number of variables including frequency of use, number of users, and attention paid to water quality maintenance. You will know it is time for a change when you cannot control sudsing and/or you can no longer get the normal feel or sparkle to the water, even though the key water balance measurements are all within the proper parameters. See pages 67-69 for additional information.

Table of Contents

1.0	Important Hot Tub Owner Information	1
2.0	FCC Notice	1
3.0	Important Safety Instructions for all Spa Owners	2
3.1	Entrapment Risk	6
3.2	Hyperthermia	7
3.3	Important Additional CSA Safety Instructions (Canada Only).....	8
4.0	Locating Your Sundance Hot Tub	8
4.1	Outdoor Location	9
4.2	Indoor Location	10
5.0	General Electrical Safety Instructions	11
6.0	Electrical Installation Instructions (240V Service)	12
7.0	Power Requirements	15
7.1	North American 60 Hz Power Options	15
7.2	Export 50 Hz Power Options.....	16
8.0	Hot Tub Fill Up Procedure	17
9.0	Hot Tub Features	22
9.1	Main Control Panel Functions.....	22
9.2	LCD Screen Functions.....	23
9.3	Maxxus Hot Tub Features.....	24
9.4	Maxxus Massage/Waterfall Selector Diagram	25
9.5	Maxxus Air Controls Diagram	26
9.6	Aspen Hot Tub Features.....	27
9.7	Aspen Massage/Waterfall Selector Diagram	28
9.8	Aspen Air Controls Diagram.....	29
9.9	Optima® Hot Tub Features.....	30
9.10	Optima Massage/Waterfall Selector Diagram	31
9.11	Optima Air Controls Diagram	32
9.12	Cameo® Hot Tub Features.....	33
9.13	Cameo Massage/Waterfall Selector Diagram	34
9.14	Cameo Air Controls Diagram	35
9.15	Altamar Hot Tub Features.....	36
9.16	Altamar Massage/Waterfall Selector Diagram	37
9.17	Altamar Air Controls Diagram	38
9.18	Majesta® Hot Tub Features.....	39
9.19	Majesta Massage/Waterfall Selector Diagram.....	40
9.20	Majesta Air Controls Diagram	41

9.21	Marin Hot Tub Features	42
9.22	Marin Massage/Waterfall Selector Diagram	43
9.23	Marin Air Controls Diagram.....	44
9.24	Capri® Hot Tub Features.....	45
9.25	Capri Massage/Waterfall Selector Diagram.....	46
9.26	Capri Air Controls Diagram	47
10.0	Operating Instructions	48
10.1	View Button.....	48
10.2	Air Injection	48
10.3	Controlling the water temperature.....	48
10.4	Activate Jets Pump 1	49
10.5	Activate Jets Pump 2/Pump 3.....	49
10.6	Light Button.....	49
10.7	Selecting The Desired Massage Action	50
10.8	Adjusting Fluidix Reflex, Nex, ST, Intelli-Jets And Focus-Relief	51
10.9	Air Controls	51
10.10	Waterfall Control	51
10.11	Fragrance Dispenser	52
10.12	Indicator Light	52
10.13	Optional BLUEWAVE® Spa Stereo System	52
11.0	Heating Modes	53
11.1	Standard Mode (Factory Default).....	53
11.2	Economy Mode.....	53
11.3	Selecting Standard or Economy Mode	53
11.4	Clean-Up “Blow-Out” Cycle.....	53
12.0	Programming Instructions.....	54
12.1	Programming Filter/Circulation Pump	54
12.2	Programmable Filter/Heating Cycles (Economy Mode Only)	55
12.3	Adjusting Time of Day.....	56
12.4	Programming The Date.....	56
12.5	Main Control Panel Lock.....	57
12.6	Temperature Setting Lock.....	57
12.7	Programming the Change Filter Reminder	58
12.8	Programming the CLEARRAY® (Ultraviolet) Water Purification System.....	58
13.0	Hot Tub Maintenance.....	60
13.1	Cleaning/Replacing the Filter Cartridge	60
13.2	Quick Release Door (Except Maxxus and Aspen Models)	62
13.3	Draining And Refilling.....	63
13.4	Cleaning The Hot Tub Interior.....	64
13.5	Pillow Care.....	64

13.6	Maintaining the Hot Tub Cabinet.....	65
13.7	Vinyl Cover Care And Maintenance.....	65
13.8	Winterizing.....	66
13.9	Restarting Your Hot Tub in Cold Weather.....	67
14.0	Water Quality Maintenance.....	67
14.1	pH Control.....	68
14.2	Sanitizing.....	68
14.3	CLEARRAY® Water Purification System.....	69
14.4	CLEARRAY® Bulb Replacement and Quartz Tube Maintenance.....	70
14.5	Other Additives.....	73
14.6	Handrail Maintenance.....	73
15.0	Troubleshooting - Display Messages.....	74
16.0	Troubleshooting - Procedures.....	76
17.0	North American 60 Hz Electrical Wiring Diagram.....	79
17.1	North American 60 Hz Maxxus/Aspen Electrical Wiring Diagram.....	79
17.2	North American 60 Hz Altamar/Cameo/Capri/Majesta/ Marin Electrical Wiring Diagram.....	80
18.0	Export 50 Hz Electrical Wiring Diagram.....	81
18.1	Export 50 Hz Maxxus/Aspen Electrical Wiring Diagram.....	81
18.2	Export 50 Hz Altamar/Cameo/Capri/Majesta/Marin Electrical Wiring Diagram.....	82
19.0	Circuit Board Pin Assignments.....	83
20.0	Typical Hot Tub Wiring Diagrams A-B (North American 60 Hz Models Only).....	84
21.0	Optional BLUEWAVE® Spa Stereo System.....	85
21.1	Pairing the Remote and Stereo.....	86
21.2	Audio Settings.....	86
21.3	Wireless Remote Control Functions.....	88
21.4	Electronic Device Connections and Functions.....	89
21.5	Wireless Remote Battery Replacement Procedure.....	92
21.6	BLUEWAVE Spa Stereo System Specifications.....	93
21.7	Stereo Cautions.....	93

1.0 Important Hot Tub Owner Information

Your Sundance® hot tub is constructed to the highest standards and is capable of providing many years of trouble-free use. However, because heat retentive materials are utilized to insulate the hot tub for efficient operation, an uncovered hot tub surface and wall fittings directly exposed to sunlight and high temperatures for an extended period are subject to permanent damage or discoloration. Damage caused by exposing the hot tub to this abuse is not covered under warranty. We recommend that you always keep the hot tub full of water when it is exposed to direct sunlight and that you keep the Sundance insulating cover in place at all times when the hot tub is not in use. Read and carefully follow the requirements for your hot tub's support base found in the Section 4.0 titled, "Locating Your Sundance Hot Tub" (page 8) or as prescribed by your authorized Sundance Spas dealer.

Sundance hot tubs constantly strives to offer the finest hot tubs available, therefore, modifications and enhancements may be made which affect the specifications, illustrations and/or instructions contained herein.

2.0 FCC Notice

This equipment has been tested and found to comply with the limits for a Class B Digital Device, pursuant to Part 15 of the FCC Rules. These limits are designed to provide reasonable protection against harmful interference in a residential installation. This equipment generates, uses and can radiate radio frequency energy and, if not installed and used in accordance with the instructions, may cause harmful interference to radio communications. However, there is no guarantee that interference will not occur in a particular installation. If this equipment does cause harmful interference to radio or television reception, which can be determined by turning the equipment off and on, the user is encouraged to try to correct the interference by one or more of the following measures:

1. Rearrange or relocate the receiving antenna;
2. Increase the separation between the equipment and receiver;
3. Connect the equipment into an outlet on a circuit different from the circuit connected;
4. Consult the dealer or an experienced radio/TV technician for help. (Changes or modifications not expressly approved by the party responsible for FCC compliance could void the user's authority to operate this equipment).

3.0 Important Safety Instructions for all Spa Owners



READ AND FOLLOW ALL INSTRUCTIONS CAREFULLY!



This spa was manufactured to meet the standards and specifications outlined in the “Virginia Graeme Baker Pool and Spa Safety Act” (VGB Safety Act). When installing and using this spa, basic safety precautions should always be followed, including:



1.  **DANGER: RISK OF SEVERE INJURY OR DROWNING!**
 - Extreme caution must be exercised to prevent unauthorized access by children.
 - To avoid accidents, ensure that children do not use this spa unless supervised at all times. Adult supervision is a critical safety factor in preventing children from drowning.
 - Use the straps and clip tie downs to secure the spa cover when not in use. This will help discourage unsupervised children from entering the spa. Keep the spa cover secure in high-wind conditions.
 - There is no representation that the cover, clip tie-downs, or actual locks will prevent access to the spa.

2.  **DANGER: RISK OF SEVERE INJURY OR DROWNING!**
 - Keep hair, loose articles of clothing or hanging jewelry away from suction fittings, rotating jets or other moving components to avoid entrapment that could lead to drowning or severe injury.
 - Never use the spa unless all suction guards, filter, filter lid, or skimmer assembly are installed to prevent body and/or hair entrapment.
 - Never operate or use the spa if the filter, filter lid, or skimmer assembly are broken or any part of the skimmer assembly is missing. Please contact your dealer or nearest service center for service.
 - The suction fittings and suction covers in this spa are sized to match the specific water flow created by the pump(s). If it is necessary to replace the suction fittings, suction covers or pump(s), be sure that the flow rates are compatible and are in compliance with the VGB Safety Act.
 - Never replace a suction fitting or suction cover with one rated less than the flow rate marked on the original suction fitting. Using improper suction fittings or suction covers can create a body or hair suction entrapment hazard that may lead to drowning or severe injury.

3.  **DANGER: RISK OF SEVERE INJURY FROM ELECTRIC SHOCK OR DEATH FROM ELECTROCUTION!**
 - Install the spa at least 5 feet (1.5m), from all metal surfaces. As an alternative, a spa may be installed within 5 feet of metal surfaces if each metal surface is permanently connected (bonded) by a minimum No. 8 AWG (8.4 mm²) solid copper conductor attached to the wire connector on the grounding lug, inside the equipment compartment on the equipment box.

- A grounding wire connector is provided on this unit to connect a minimum No. 8 AWG (8.4 mm²) solid copper conductor between this unit and any metal equipment, metal enclosures of electrical equipment, metal water pipe, or conduit within 5 feet (1.5m) of the unit.
 - Never permit any electrical appliance, such as a light, telephone, radio, television, etc. within 5 feet (1.5m) of a spa unless such appliances are built-in by the manufacturer.
 - Never bring any electrical appliances into or near the spa.
 - Never operate any electrical appliances from inside the spa or when you are wet.
 - The electrical supply for this product must include a suitably rated switch or circuit breaker to open all ungrounded supply conductors to comply with section 422-20 of the National Electrical Code/ USA, ANSI/NFPA 70. The disconnecting means must be readily accessible and visible to the spa occupant but installed at least 5 feet (1.5m), from the spa.
 - The electrical circuit supplied for the hot tub must include a suitable ground fault circuit interrupter (GFCI) as required by NEC Article 680-42.
4.  **WARNING: RISK OF SEVERE INJURY OR DEATH!**
- Extreme caution must be exercised to prevent diving or jumping into the spa or slipping and falling, which could result in unconsciousness, drowning, or serious injury. Remember that wet surfaces can be very slippery.
 - Never stand, walk or sit on the top railing of the spa.
5.  **WARNING: RISK OF HYPERTHERMIA (OVER-HEATING) CAUSING SEVERE INJURY, BURNS, WELTS OR DEATH!**
- Water temperature in excess of 104°F (40°C) may be injurious to your health.
 - Refer to Section 3.2 Hypertthermia for specific causes and symptoms of this condition.
 - The water in the spa should never exceed 104°F (40°C). Water temperatures between 100°F (38°C) and 104°F (40°C) are considered safe for a healthy adult.
 - Lower water temperatures are recommended for young children (children are especially sensitive to hot water) and when spa use may exceed 10 minutes.
 - The Consumer Products Safety Commission/USA has stated that the water temperature in a spa should not exceed 104°F (40°C).
 - Always test the spa water temperature before entering the spa. The user should measure the water temperature with an accurate thermometer since the tolerance of water temperature-regulating devices may vary as much as +/- 5°F (2°C).

6.  **WARNING: RISK OF SEVERE INJURY OR DEATH!**
- Since excessive water temperatures have a high potential for causing fetal damage during the early months of pregnancy, if pregnant or possibly pregnant, consult your physician before using a spa.
 - Pregnant or possibly pregnant women should limit spa water temperatures to 100°F (38°C).
 - Persons suffering from obesity or a medical history of heart disease, low or high blood pressure, circulatory system problems, diabetes, infectious diseases or immune deficiency syndromes should consult a physician before using a spa.
 - If you experience breathing difficulties in association with using or operating your spa, discontinue use and consult your physician.
 - Persons using medication should consult a physician before using a spa since some medication may induce drowsiness, while other medication may affect heart rate, blood pressure, and circulation.
 - Persons suffering from any condition requiring medical treatment, the elderly, or infants should consult with a physician before using a spa.
 - The use of alcohol, drugs, or medication before or during spa use may lead to unconsciousness with the possibility of drowning.
7.  **WARNING: RISK OF SEVERE INJURY OR DEATH!**
- Prolonged immersion in a spa may be injurious to your health.
 - Observe a reasonable time limit when using the spa. Exposures at higher temperatures can cause high body temperature (overheating). Symptoms may include dizziness, nausea, fainting, drowsiness, and reduced awareness. These effects could possibly result in drowning or serious injury.
 - Never use a spa immediately following strenuous exercise. Enter and exit the spa slowly. Wet surfaces can be slippery.
8.  **WARNING: TO DECREASE RISK OF INFECTION OR DISEASE!**
- To reduce the risk of contracting a waterborne illness (e.g. an infection, bacteria or virus) and/or respiratory ailments, maintain water chemistry within the parameters listed on the inside cover of this manual and consult with a licensed engineer regarding proper ventilation if installed indoors or in an enclosed area.
 - People with infectious diseases should not use a spa to avoid water contamination, which could result in spreading infections to others.
 - Always shower before and after using your spa. Maintain water chemistry in accordance with manufacturer's instructions. Failure to do so may result in contracting a waterborne illness (e.g. an infection, bacteria or virus).

9.  **WARNING:** In addition to maintenance of filters and water chemistry, proper ventilation is recommended to reduce the risk of contracting a waterborne illness (e.g. an infection, bacteria or virus) and/or respiratory ailments that could be present in the air or water. Consult a licensed architect or building contractor to determine your specific needs if installing your hot tub indoors.
10. **CAUTION: TO DECREASE RISK OF PRODUCT DAMAGE.**
- Maintain water chemistry in accordance with manufacturer's instructions.
 - Proper chemical maintenance of spa water is necessary to maintain safe water and prevent possible damage to spa components.
11.  **WARNING: RISK OF SEVERE INJURY OR DEATH!**
The appliance is not intended for use by persons (including children) with reduced physical, sensory or mental capabilities, or lack of experience or knowledge, unless they have been given supervision or instruction concerning use of the appliance by a person responsible for their safety.
12. **NOTE:** This spa is not intended nor designed to be used in a commercial or public application. The spa buyer shall determine whether there are any code restrictions on the use or installation of this spa since local code requirements vary from one locality to another.

Hot Tub Safety Literature

To ensure you have a safe and enjoyable hot tub experience, learn all you can about hot tub safety and emergency procedures. Especially useful are the brochures listed below:

- [Children Aren't Waterproof](#)
- [Pool and Spa Emergency Procedures For Infants and Children](#)
- [Layers of Protection](#)
- [The Sensible Way to Enjoy Your Spa or Hot Tub](#)

The Association of Pool and Spa Professionals publishes these brochures. To acquire a brochure:

- Ask your hot tub dealer (they may have copies)
- Go to <http://www.apsp.org>
- Conduct your own search on the internet
- Write to the following address:

The Association of Pool and Spa Professionals
2111 Eisenhower Avenue
Alexandria VA 22314
703.838.0083

3.1 Entrapment Risk

The Consumer Products Safety Commission/USA has reported that users of pools and spas have become entrapped (stuck) to drain and/or suction fittings causing death, drowning, or serious injury (see diagram below). This spa was manufactured to meet the standards and specifications outlined in the "Virginia Graeme Baker Pool and Spa Safety Act" (VGB Safety Act). Entrapment risk can be minimized if proper precautions are taken.





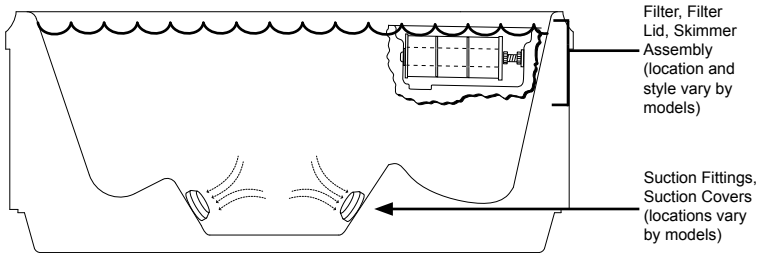

DANGER: RISK OF PERSONAL INJURY OR DEATH!

Never operate the spa if a suction fitting, suction cover, filter, filter lid or skimmer assembly are broken, damaged or missing.



NOTE: SUCTION COVERS MUST BE REPLACED EVERY 5 YEARS.

1.  **DANGER: RISK OF SEVERE INJURY OR DROWNING!**
Hair entrapment: May occur if hair is entangled, knotted or snagged in a drain suction or skimmer assembly. This has been reported in persons who when submerge themselves underwater, allowing hair to come close and/or within the reach of the suction fittings, suction covers or skimmer assembly.
 - Keep hair away from suction fittings, suction covers, filter, filter lid or skimmer assembly.
 - Children are at risk for hair entrapment if swimming under water.
 - Never allow children to play or get near the suction fittings, suction covers, filter, filter lid or skimmer assembly.
2.  **DANGER: RISK OF SEVERE INJURY OR DROWNING!**
Limb entrapment: May occur when a limb becomes entrapped, inserted or sucked into a suction or outlet opening.
 - Always keep suction fittings, suction covers, filter, filter lid or skimmer assembly in place when operating to avoid limb entrapment.
 - Never allow children to play or get near the suction fittings, suction covers, filter, filter lid or skimmer assembly.

3.  **DANGER: RISK OF SEVERE INJURY OR DROWNING!**
Body entrapment: May occur when part of the torso becomes entrapped, inserted or sucked into a suction or outlet opening.
 - Never allow children to play or get near the suction fittings, suction covers, filter, filter lid or skimmer assembly.
4.  **DANGER: RISK OF SEVERE INJURY OR DROWNING!**
Evisceration (disembowelment) entrapment: May occur when the buttocks becomes entrapped, inserted or sucked into a suction or outlet opening.
 - Never sit on suction fittings, suction covers, filter, filter lid or skimmer assembly.
 - Never allow children to play or get near the suction fittings, suction covers, filter, filter lid or skimmer assembly.
5.  **DANGER: RISK OF SEVERE INJURY OR DROWNING!**
Mechanical entrapment: May occur when jewelry, swimsuit, or hair accessories become entangled, knotted or snagged in a drain suction or skimmer assembly.
 - Never allow your jewelry, swimsuit, or hair accessories to come close to the suction fittings, suction covers or skimmer assembly.
 - Never allow children to play or get near the suction fittings, suction covers, filter, filter lid or skimmer assembly.

3.2 Hyperthermia

Prolonged immersion in hot water may induce hyperthermia (overheating). The use of alcohol or drugs can greatly increase the risk of fatal hyperthermia in spas. A description of the causes, symptoms, and effects of hyperthermia are as follows:

Hyperthermia occurs when the internal temperature of the body reaches a level several degrees above the normal body temperature of 98.6°F (37°C). The symptoms of hyperthermia include drowsiness, lethargy (fatigue), and an increase in the internal temperature of the body (feeling of being too hot). The effects of hyperthermia include:

- Unawareness of impending hazard;
- Failure to perceive heat;
- Failure to recognize the need to exit spa;
- Physical inability to exit spa;
- Fetal damage in pregnant women; and
- Unconsciousness and danger of drowning.

A Warning Sign is provided in your warranty packet. Please install at a location near your spa, where it is visible to users of the spa. For additional or replacement Warning Signs please contact your local Sundance spas dealer and reference item number #6530-082.

3.3 Important Additional CSA Safety Instructions (Canada Only)

When using this electrical equipment, basic safety precautions should always be followed, including the following:

- 1. READ AND FOLLOW ALL INSTRUCTIONS.**
- A green colored terminal or a terminal marked G, Gr, Ground, Grounding or the \oplus symbol* is located inside the supply terminal box or compartment. To reduce the risk of electric shock, this terminal must be connected to the grounding means provided in the electric supply service panel with a continuous copper wire equivalent in size to the circuit conductors that supply this equipment (*IEC Publication 417, Symbol 5019).
- At least two lugs marked "Bonding Lugs" are provided on the external surface or on the inside of the supply terminal box/compartment. To reduce the risk of electric shock, connect the local common bonding grid in the area of the spa to these terminals with an insulated or bare copper conductor not smaller than No. 6 AWG (10 mm²).
- All field installed metal components such as rails, ladders, drains or other similar hardware within 10 feet (3m) of the spa shall be bonded to the equipment grounding buss with copper conductors not smaller than No. 6 AWG (10 mm²).
- 5. SAVE THESE INSTRUCTIONS.**

4.0 Locating Your Sundance Hot Tub

IMPORTANT: Because of the combined weight of the spa, water and users, it is extremely important that the base upon which the spa rests be smooth, flat, level and capable of uniformly supporting this weight, without shifting or settling, for the entire time the spa is in place. If the spa is placed on a surface which does not meet these requirements, damage to the skirt and/or the spa shell may result. Damage caused by improper support is not covered under warranty. It is the responsibility of the spa owner to assure the integrity of the support over time. We recommend a poured, reinforced concrete slab with a minimum thickness of 4 inches (10 cm). Wood decking is also acceptable provided it is constructed so that it meets the requirements outlined above.



WARNING: For spas that are to rest on balconies, roofs or other platforms not specifically tied into main structural support, consult a professional Structural Engineer with experience in this type of application.

The spa must be installed in such a manner as to provide drainage away from it. Placing the spa in a depression without provisions for proper drainage could allow rain, overflow and other casual water to flood the equipment and create a wet condition in which it would sit in. For spas which will be recessed into a floor or deck, install so as to permit access to the equipment, either from above or below, for servicing. Make certain that there are no obstructions which would prevent removal of all side cabinet panels and access to components, especially on the side with the equipment bay doors.



CAUTION: If the spa is indoors or located in an enclosed area, proper ventilation should be discussed with an Engineer or authority competent enough to understand the necessary provisions needed to vent moist or heated air and air associated with chemical odors outdoors. **When the spa is in use considerable amounts of moisture will escape potentially causing mold and mildew.** This can cause health risk. Over time, this can damage certain surfaces, surroundings, and equipment.

4.1 Outdoor Location

In selecting the ideal outdoor location for your hot tub, we suggest that you take into consideration the following:

- The proximity to changing area and shelter (especially in regions subject to cold weather).
- The pathway to and from your hot tub (this should be free of debris so that dirt and leaves are not easily tracked into the hot tub).
- The closeness to trees and shrubbery (remember that leaves and birds could create extra work in keeping the hot tub clean).
- A sheltered environment (less wind and weather exposure can result in lowered operation and maintenance costs).
- The overall enhancement of your environment. It is preferable not to place the hot tub under an unuttered roof overhang since run-off water will shorten the life expectancy of the hot tub cover.
- For spas that are to rest on balconies, roofs or other platforms not specifically tied into main structural support, consult a professional Structural Engineer with experience in this type of application.
- In the unlikely event that you should ever need to access or gain entry to any portion of the spa for servicing, it is highly recommended that you plan your outdoor installation to provide full access to the entire spa. Please take this into consideration when placing the spa in a deck or enclosed by a surrounding.

- Consider locating your spa away from any reflective surface or glass to prevent any damage to the synthetic skirt.
- Do not shim the spa. To ensure proper support the spa must sit flat on the intended foundation.

4.2 Indoor Location

For indoor installations many factors need to be considered before installing a spa indoors:



WARNING: In addition to maintenance of filters and water chemistry, proper ventilation is recommended to reduce the risk of contracting a waterborne illness (e.g. an infection, bacteria or virus) and/or respiratory ailments that could be present in the air or water. Consult a licensed architect or building contractor to determine your specific needs if installing your hot tub indoors.

- **PROPER FOUNDATION:** Consult a Structural Engineer when considering a foundation that will adequately support the spa the entire time it is in place. Proper support is critical especially if the spa is to rest on a second story or higher. For spas that are to rest on balconies, roofs or other platforms not specifically tied into the main structural support, you should consult a professional Structural Engineer with experience in this type of application.
- **PROPER DRAINAGE:** It is extremely important to have in place measures to sufficiently handle excessive water spillage. Be sure the flooring in which the spa rests on has adequate drainage and can handle draining of the entire contents of the spa. Be sure to make provisions for ceilings or any other structures that may be below the spas installation. Areas around your spa can become wet or moist so all flooring and subsequent furniture, walls and adjacent structures should be able to withstand or resist water and moisture.
- **PROPER VENTILATION:** Proper ventilation should be discussed with an Engineer or authority competent enough to understand the necessary provisions needed to vent moist or heated air and air associated with chemical odors outdoors. When the spa is in use considerable amounts of moisture will escape potentially causing mold and mildew, over time this can damage certain surfaces and or surroundings.

- **SUFFICIENT ACCESS:** In the unlikely event that you should ever need to access or gain entry to any portion of the spa for servicing, it is highly recommended that you plan your indoor installation to provide full access to the entire spa.
- **WARRANTY:** Damage caused by not following these guidelines or any improper installation not in accordance with local codes or authorities is not covered under the spas warranty. Please consult your local state or city building ordinances.
- **DO NOT SHIM THE SPA.** To ensure proper support the spa must sit flat on the intended foundation.

5.0 General Electrical Safety Instructions

Your new Sundance® hot tub is equipped with the “state-of-the-art” equipment system. It contains the most advanced safety and self-protective equipment in the industry.

Nonetheless, this hot tub must be installed properly to ensure dependable usage. Please contact your local Sundance Spas dealer or local building department should you have any questions regarding your installation.

Proper grounding is extremely important. Sundance hot tubs are equipped with a current collector system. A pressure wire connector is provided on the surface of the control box, located inside the equipment door (Figure C, page 14) to permit connection of a bonding wire between this point and any ground metal equipment, metal water pipe or conduit within 5 feet (1.5m) of the hot tub, or copper clad grounding rod buried within 5 feet (1.5m) of the hot tub. Bonding wire must be at least No. 8 AWG (8.4 mm²) solid copper wire. This is a most important safety assurance feature.

Before installing your hot tub, check with your local government/electrical authority to ensure installation conforms to local country/area state codes.

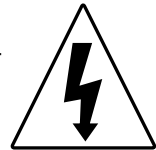

6.0 Electrical Installation Instructions (240V Service)

IMPORTANT NOTICE: The electrical wiring of this hot tub must meet the requirements of the National Electrical Code (NEC) and any applicable state, local or country codes. The electrical circuit must be installed by a qualified electrician and approved by a local building/electrical inspection authority in your state or country.

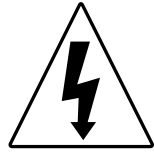

1.  **DANGER: TO DECREASE THE RISK OF SHOCK, PRODUCT DAMAGE OR ELECTRICAL FIRE.**

This hot tub must be permanently connected (hard-wired) to the power supply. **No plug-in connections or extension cords are to be used in conjunction with the operation of this hot tub.**

Supplying power to the hot tub which is not in accordance with these instructions will void both the independent testing agency listing and the manufacturer's warranty.

2. The power supplied to this hot tub must be a dedicated circuit with no other appliances or lights sharing the power provided by the circuit.
3. To determine the current, voltage and wire size required, refer to Section 7.0 (page 15) for your specific hot tub model.
 - Wire size must be appropriate per NEC and/or local/country codes.
 - We recommend type THHN wire.
 - All wiring must be copper to ensure proper connections. Do not use aluminum wire.
 - When using wire larger than #6 (10 mm²), add a junction box near the hot tub and reduce to short lengths of #6 (10 mm²) wire to connect to the hot tub.
4. The electrical supply for this product must include a suitably rated switch or circuit breaker to open all ungrounded supply conductors to comply with Section 422-20 of the National Electrical Code, ANSI/NFPA 70. The disconnecting means must be readily accessible and visible to the hot tub's occupant but installed at least 5 feet (1.5m) from the hot tub.
5. The electrical circuit supplied for the hot tub must include a suitable ground fault circuit interrupter (GFCI) as required by NEC Article 680-42.
6. To gain access to the hot tub's power terminal block, remove the four screws securing the center cabinet panel (Maxxus™ and Aspen® models only) or the Quick Release buttons (except Maxxus and Aspen models) on the side of the hot tub under the controls. Then remove the four control box door screws and door (Figure C, page 14).

7. For Australia/New Zealand, the spa should be supplied through a residual current device (RCD) with a rated tripping current not exceeding 30mA (IEC 60335-2-60).
8. Select the power supply entrance you want to use (Figures A-B, pages 13-14) and remove the short cabinet panel from the front of the hot tub, then feed cable through the large opening provided on the bottom of the control box.
9. Connect wires, color to color, on terminal blocks TB1 and TB3 (Figure D). TIGHTEN SECURELY! All wires must be hooked up securely or damage could result.
10. Install control box door and reinstall the cabinet side panels.

Figure A (Maxxus/Aspen Equipment Area)

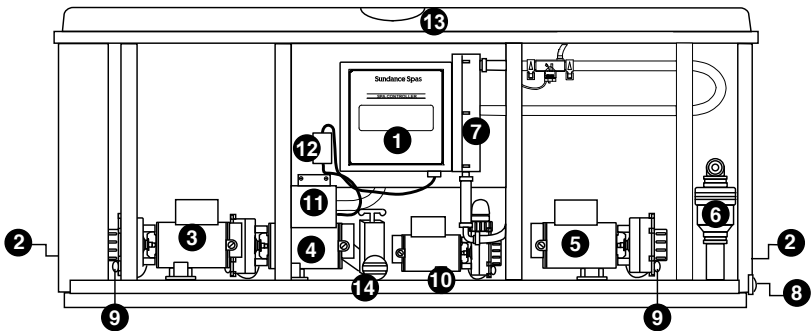

Note: Equipment location (such as pumps, CLEARRAY® system, drain, heater etc.) varies by model.

- | | |
|---|---|
| 1. Control Box | 9. Pump Drain Plug(s) |
| 2. Power Supply Entrance(s) | 10. Filter/Circulation Pump |
| 3. Jets Pump | 11. CLEARRAY® (Ultraviolet) Water Purification System |
| 4. Jets Pump | 12. Electronic Ballast (for the CLEARRAY System) |
| 5. Jets Pump | 13. Control Panel |
| 6. Blower | 14. Quick Drain |
| 7. Heater | |
| 8. Hot Tub Drain (Removable External Drain Cap) | |

Figure B (Equipment Area for All Models Except Maxxus/Aspen)

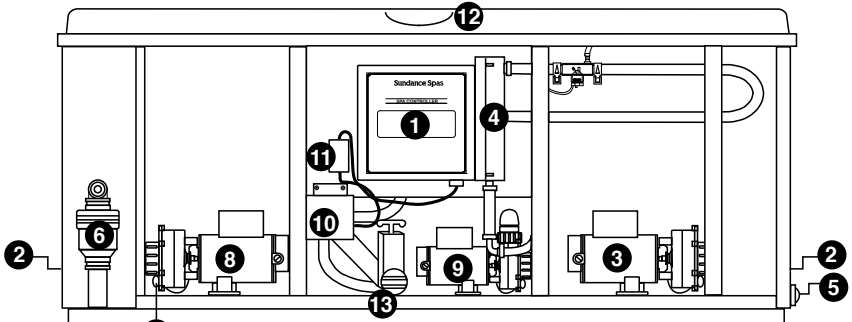

Note: Equipment location (such as pumps, CLEARRAY® system, drain, heater etc.) varies by model.

- | | |
|---|---|
| 1. Control Box | 8. Jets Pump |
| 2. Power Supply Entrance(s) | 9. Filter/Circulation Pump |
| 3. Jets Pump | 10. CLEARRAY® (Ultraviolet) Purification System |
| 4. Heater | 11. Electronic Ballast (for CLEARRAY System) |
| 5. Hot Tub Drain (Removable External Drain Cap) | 12. Control Panel |
| 6. Air Blower | 13. Quick Drain |
| 7. Pump Drain Plug(s) | |

Figure C
Control Box

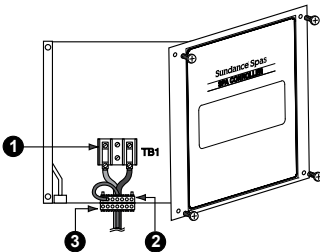

1. Terminal Block
2. Bonding Lug
3. Grounding Terminal

Figure D
Terminal Block 240V
Wire Connection
60 Hz

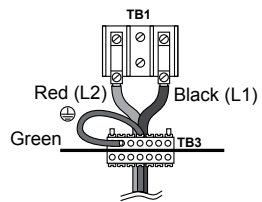

50 Hz
(refer to pages 81 and 82 for wiring diagram)

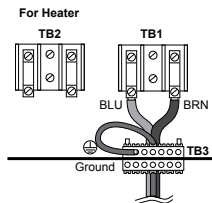

Single Breaker Connection

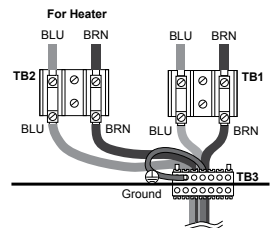

Double Breaker Connection

7.0 Power Requirements

Sundance® hot tubs are designed to provide optimum performance and flexibility of use when connected to their maximum electrical service. However, they are shipped factory configured for their most common preferred electrical connection.

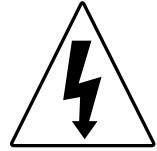

If you prefer, a qualified technician can perform a minor circuit board modification that allows the hot tub to operate on a different electrical service (see table below).

7.1 North American 60 Hz Power Options

North American 60 Hz Maxxus/Aspen

	<u>240V/50A*</u>	<u>240V/60A**</u>
Voltage	240 VAC	240 VAC
Max. Current Draw	38A	48A
Number of Wires	3	3
Circuit Breaker (2-Pole)	50A*	60A**

* In this configuration, the heater **will not operate** while any two jets pumps are running.

** In this configuration the heater **will operate while** any two jets pumps and the blower are running but **will not operate** when all three jets pumps are running. **This is the factory default setting.**

North American 60 Hz Altamar/Cameo/Majesta/Marin/Optima

	<u>240V/40A*</u>	<u>240V/50A**</u>	<u>240V/60A***</u>
Voltage	240 VAC	240 VAC	240 VAC
Max. Current Draw	26A	40A	48A
Number of Wires	3	3	3
Circuit Breaker (2-Pole)	40A*	50A**	60A***

* In this configuration, the heater **will not operate** while either jets pump is running or when the blower is running.

** In this configuration, the heater **will not operate** while both jet pumps are running. **This is the factory default setting.**

*** In this configuration the heater **will operate while** both jets pumps and the blower are running.

North American 60 Hz Capri

	<u>240V/40A*</u>	<u>240V/50A**</u>
Voltage	240 VAC	240 VAC
Max. Current Draw	26A	40A
Number of Wires	3	3
Circuit Breaker (2-Pole)	40A*	50A**

* In this configuration, the heater **will not operate** while the jets pump is running or when the blower is running.

** In this configuration, the heater **will operate** while the jets pump and blower are running. **This is the factory default setting.**

7.2 Export 50 Hz Power Options

Export 50 Hz Maxxus/Aspen

	<u>230V/27.7A*</u>	<u>230V/35.6A**</u>	<u>230V/43.6A***</u>
Voltage	230 VAC	230 VAC	230 VAC
Frequency	50 Hz	50 Hz	50 Hz
Max. Current Draw	27,7A	35,6A	43,6A
Wattage	6,0 kW	8,2 kW	10,0 kW
Number of Wires	3	3	3

* In this configuration, the heater **will not operate** while either jets pump is running or when the blower is running.

** In this configuration, the heater **will not operate** while any two jets pumps are running.

*** In this configuration the heater **will operate while** any two jets pumps and the blower are running but **will not operate** when all three jets pumps are running. **This is the factory default setting.**

Export 50 Hz Altamar/Cameo/Majesta/Marin/Optima

	<u>230V/19,7A</u>	<u>230V/31,4A</u>
Voltage	230 VAC	230 VAC
Frequency	50 Hz	50 Hz
Max. Current Draw	19,7 Amps*	31,4 Amps**
Wattage	4,5 kW	7,2 kW
Number of Wires	3	3

* Standard 19,7 Amp (4,5 kW) configuration. The heater **will not operate** while both jets pump are running.

** Alternate 31,4 Amp (7,2 kW) configuration, the heater **will operate** while jets pumps are running.

Export 50 Hz Capri

	<u>230V/12,1A</u>	<u>230V/23,6A</u>
Voltage	230 VAC	230 VAC
Frequency	50 Hz	50 Hz
Max. Current Draw	12,1 Amps*	23,6 Amps**
Wattage	2,8 kW	5,4 kW
Number of Wires	3	3

- * Standard 12,1 Amp (2,8 kW) configuration. The heater **will not operate** while the jets pump is running.
- ** Alternate 23,6 Amp (5,4 kW) configuration. The heater **will operate** while the jets pump is running.

8.0 Hot Tub Fill Up Procedure

For best results, read each step in its entirety before proceeding with that step.

1. Prepare The Hot Tub For Filling

- Clear all debris from the hot tub. (Although the hot tub shell has been polished at the factory, you may want to treat it with a specially formulated hot tub cleaner.) Consult your dealer for additional information prior to filling hot tub.
- Remove filter lid (Sections 9.3-9.24, pages 24-45), then remove filter cartridge from filter bucket as illustrated in Section 13.1.

2. Fill Hot Tub

- Place the end of your garden hose into the empty filter bucket.

CAUTION: TO DECREASE BUILD UP ON COMPONENTS AND MINIMIZE ACRYLIC DAMAGE.

Never fill with water from a water softener. If your water is extremely "hard," it is preferable to fill half-way with hard water and the rest of the way with softened water. Water that is too soft can be corrosive to metal components.

-  **WARNING: TO DECREASE RISK OF INFECTION OR DISEASE.**

Fill hot tub with clean tap water from garden hose, to reduce risk of contracting a waterborne illness (e.g. an infection, bacteria or virus) and/or respiratory ailments. Fill until water covers all jets but does not touch the bottom of the lowest headrest. (DO NOT OVERFILL!)

IMPORTANT: Always fill your hot tub through the filter bucket after draining. Failure to do so may cause air to be trapped in either pump, preventing the pump from circulating water. Remove the hose and replace the filter cartridge as illustrated in Section 13.1.

3. Turn On Power

Turn on power to hot tub at the home's circuit breaker to start boot up sequence. The heater and filter/circulation pump will automatically activate. If the control panel LCD flashes water temperature and "COOL" or "ICE," this is normal.

4. Activate Jets Pumps

Turn on all jet(s) pumps and blower to ensure proper mixing when adding start up chemical in step 5.



5. Add Start-Up Chemicals

Add the hot tub water chemicals as recommended by your Sundance Spas dealer. See Section titled "Water Quality Maintenance" (page 67) for general guidance.



WARNING: RISK OF POISONING OR DEATH.

Never leave chemicals opened and accessible to anyone. Use chemicals according to the vendors instructions. Always store chemicals in a safe and/or locked location. Keep away from and out of reach of children.

6. Establish A Stable Sanitizer Reading

Establish a stable sanitizer reading no less than 1.0 ppm free chlorine or 2.0 ppm bromine. To ensure healthy water conditions, always maintain a constant sanitizer reading within the levels recommended on the inside cover of this manual. If sanitizer levels cannot be stabilized, perform the decontamination procedure steps 9-15 on the following page.

Note: The "decontamination procedure" steps 9-15 should also be used after the hot tub has been "Winterized" (Section 13.9) or has been sitting without power for an extended period.

7. Set Hot Tub To Heat

To warm hot tub water to a comfortable temperature, follow these steps:

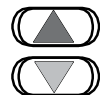

- The LCD display on the control panel displays the actual temperature of the hot tub water. Press either the **COOLER** (Down) or **WARMER** (Up) button once to display the "set" temperature for 5 seconds. If you want the water to heat to a different temperature, simply press **COOLER** or **WARMER** within 5 seconds. The set

temperature increases or decreases by one degree each time either button is pressed.

- The heater will turn off when the temperature corresponding to the thermostat setting is achieved.

Important Heater Details:

- The maximum temperature for which the hot tub can be set is 104°F (40°C) and the minimum is 80°F (27°C).
- For Cameo and Optima hot tubs powered with a 40 amp service, turn off jets pump #1 and jets pump #2 to operate heater.
- Setting the thermostat at maximum will not accelerate the heating process. This will only result in a higher ultimate temperature.
- The heater operates until the water reaches the programmed “set temperature,” then turns off. The heater will reactivate after the water cools to approximately 1° below the “set temperature.”

8. Place Cover On Hot Tub

- Keeping the insulating cover in place anytime the hot tub is not in use will reduce the time required for heating, thereby minimizing operating costs.
- The time required for initial heat-up will vary depending on the starting water temperature.



DANGER: RISK OF PERSONAL INJURY.

Check water temperature carefully before entering hot tub!
Excessive water temperature can cause burns, welts and body temperature to rise, hyperthermia (over-heating).

Decontamination Procedure (Steps 9-15)

Steps 9-15 below are only required when sanitizer levels are unstable after performing steps 1-6 above. Disregard steps 9-15 below if sanitizer levels remain stable after performing steps 1-6 above (refer to the inside cover of the manual).

9. Add 2.5 ounces (71 g.) of sodium dichlor for every 100 gallons (378 L.) of water. Refer to the table (below) for approximate water fill capacity by model.



CAUTION: RISK OF PERSONAL INJURY OR SPA DAMAGE!

Never add chlorine tablets (trichlor) or acid to your hot tub for any reason! These chemicals may damage components within your hot tub, burn or irritate your skin, create a rash, and void the manufacturer warranty for your spa.

Water Fill Volume

Model	Average Fill Volume*	Sodium Dichlor
Altamar	390 Gal (1,476 L)	10.0 oz
Aspen	563 Gal (2,131 L)	14.0 oz
Cameo	370 Gal (1,401 L)	9.0 oz
Capri	230 Gal (871 L)	6.0 oz
Majesta	330 Gal (1,249 L)	8.0 oz
Marin	315 Gal (1,192 L)	8.0 oz
Optima	410 Gal (1,552 L)	10.25 oz
Maxxus	570 Gal (2,158 L)	14.25 oz

*Use average fill volume for chemical maintenance

10. Leave hot tub cover open during this step to allow excessive chemical vapors to exit hot tub, protecting pillows and plastic knobs from chemical attack. If hot tub is indoors, open doors and windows for proper ventilation. Turn on all hot tub jets pumps for one hour, open all air controls, turn on the blower, and place all massage selector knob(s) in their center “combo” position as shown (right).



Note: You will need to press the jets pump button(s) and blower button every 20 minutes since these functions have an automatic 20 minute time-out function that turns them off.



WARNING: RISK OF PERSONAL INJURY!

- To decrease the risk of injury, drowning or entrapment, never leave your hot tub unattended for any reason while the cover is open and accessible, especially to small children and animals!
- Precautions should be taken to minimize your exposure to chemical vapors (that could cause lung, brain, or skin damage).

11. Turn off power to the hot tub at the circuit breaker, then drain tub as outlined in Section 13.3 (page 63).

12. Refill hot tub with clean tap water from garden hose until water covers all jets but does not touch the bottom of the lowest headrest. (DO NOT OVERFILL!)

CAUTION: TO DECREASE BUILD UP ON COMPONENTS AND MINIMIZE ACRYLIC DAMAGE.

Never fill with water from a water softener. If your water is extremely “hard,” it is preferable to fill half-way with hard water and the rest of the way with softened water. Water that is too soft can be corrosive to metal components.

13. Consult your authorized Sundance Spas dealer for chemical recommendations, then add chemicals to hot tub water to achieve a constant sanitizer reading within the levels recommended on the inside cover of this manual.
14. Turn on all jet pumps and the blower when adding chemicals to ensure proper mixing and leave your hot tub cover open until the sanitizer level becomes stable to protect pillows and plastic knobs from chemical attack. Refer to the inside cover of the manual.

**WARNING: RISK OF PERSONAL INJURY.**

- To decrease the risk of injury, entrapment or drowning, never leave your hot tub unattended for any reason, especially if while the cover is open and accessible to small children and animals!
- To decrease the risk of contracting a waterborne illness (e.g. an infection, bacteria or virus) and/or respiratory ailments, maintain water chemistry within 6 step parameters. If you or other bathers experience such a condition, discontinue use and seek immediate medical attention.

15. Establish a sanitizer reading no less than 1.0 ppm free chlorine or 2.0 ppm bromine, then allow the hot tub to set undisturbed for 8 hours. Retest water after 8 hours to determine if sanitizer levels are stable. If sanitizer levels are stable, your hot tub is ready for use. To ensure healthy water conditions, always maintain a constant sanitizer reading within the levels recommended on the inside cover of this manual. If sanitizer levels are not stable at this time, it will be necessary to repeat this procedure in its entirety (steps 1-15) until stable sanitizer readings are achieved.

IMPORTANT: If the CLEARRAY® water purification system is removed from the hot tub or is not operating efficiently follow the “without CLEARRAY®” water chemistry parameters. Such parameters are defined by the Association of Pool and Spa Professionals.

16. After adequate sanitizer levels are achieved, close all spa air controls by rotating them clockwise to maximize heat retention when spa is not in use.



9.0 Hot Tub Features

9.1 Main Control Panel Functions

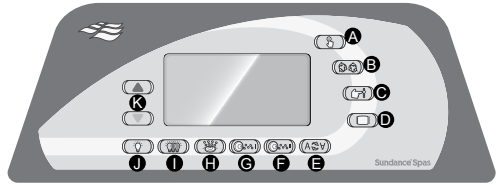
- A. **Select Button:** Scrolls menu through filter cycle programming features. Manually activates the circulation pump when it is in an off state for a 1 hour duration.



2 or 3 Pump Spa Control Panel

- B. **Cycle Button:** Accesses filter cycle program mode and advances display to next cycle.
- C. **Mode Button:** Switches between Standard and Economy modes.
- D. **Display Button:** Displays time of day and initiates time setting and locking functions.
- E. **Invert Button:** Inverts the main 4-digit LCD display.
- F. **Jets 2 Button:** Controls jets pump #2 (and Maxxus/Aspen Jets pump #3).
- G. **Jets 1 Button:** Controls jets pump #1.
- H. **Blower Button:** Controls air blower.
- I. **Light Mode Button:** Selects one of 4 color modes for waterfall, footwell and air control lights.
- J. **Light Button:** Turns waterfall, footwell air control lights on in unison. Press once for high intensity; press a second time for medium intensity; press a third time for low intensity; press a fourth time to turn off. The displayed color is changed using the light mode button.
- K. **Warmer () and Cooler () Buttons:** These buttons display and increase or decrease temperature setting and other programming features.

Operation Details:

- **Temperature Adjustment:** 80 to 104°F (26 to 40°C). Up to 106°F (41°C) with the overtemp feature.
- **Light Operation:** Lights run for 2 hours then shut off for increased bulb life.
- **Jets Buttons:** Jets run for 20 minutes after activated then turn off automatically to conserve energy.

9.2 LCD Screen Functions

 = Lock: Indicates panel, set temperature, or filter cycle programming is locked.

 = Heat: Indicates heater is on.

 = Sanitizer: Indicates that the sanitizing system is on (page 69). The Electronic Ballast (page 13) solid red light indicates that the CLEARRAY® System is activated. A solid green light indicates that the system is being provided power.

 = Adjust Filter Cycle: Indicates filter cycle programming feature is accessed.

 = Filter Cycle Number: Indicates which programmed filter cycle is running.

 = Filter Cycle: Indicates programmed filter cycle is running.

 = Filter Cycle Start Time: Indicates filter cycle start time programming is accessed.

 = Filter Cycle Duration: Indicates filter cycle duration programming is accessed.

 = Set Temperature: Indicates current set temperature is displayed.

 = Set Time: Indicates current time is displayed.

 = Filter Annunciator: Indicates filter cleaning and/or replacement is required.

 = Blower: Indicates blower is on.

 = Jets 1: Indicates jets pump 1 is on.

 = Jets 2: Indicates jets pump 2 is on (also shown for Maxxus/Aspen Pump 3).

STANDARD = Mode: Indicates selected filter mode.

Note: No icon means Economy mode is selected.

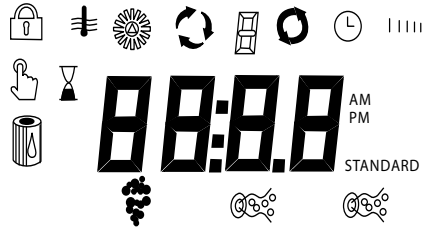

9.3 Maxxus Hot Tub Features

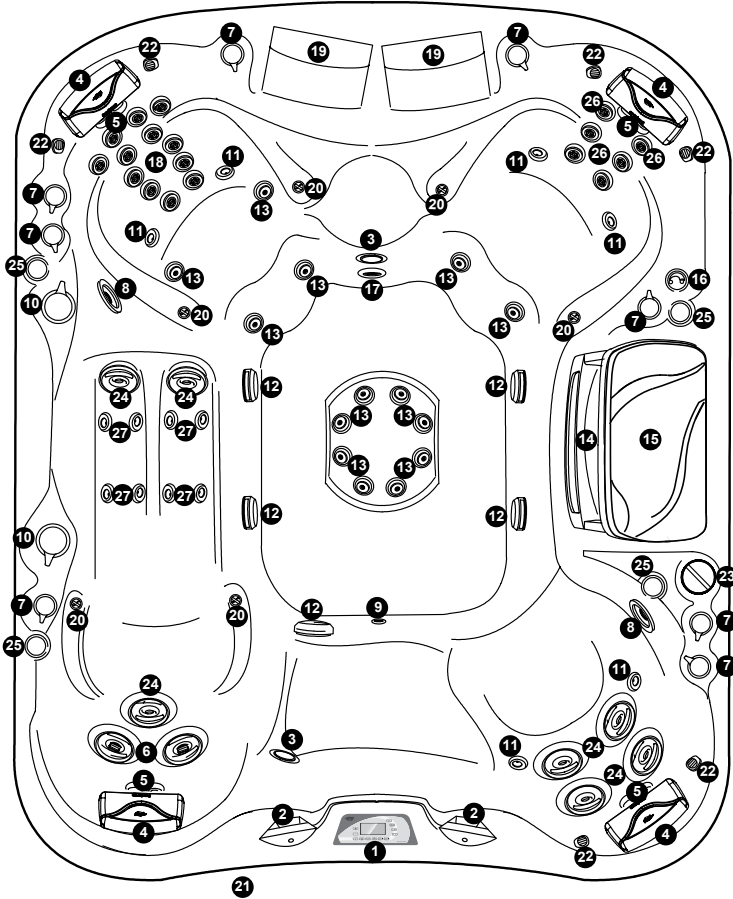

- | | |
|--|---|
| <ol style="list-style-type: none"> 1. Main Control Panel 2. Handrails with LED Light (2 ea.) 3. Lights (2 ea.) 4. Pillows (4 ea.) 5. Fluidix Nex Jets (8 ea.) 6. Fluidix Intelli-Jets (2 ea.) 7. Air Controls with LED Light (8 ea.) 8. Whirlpool Jets (2 ea.) 9. Gravity Drain 10. Massage Selectors (2 ea.) 11. Air Injectors (6 ea.) 12. Suction Covers (6 ea.; one is not shown) 13. Accu-Pressure Jets (14 ea.) 14. Weir Gate/Skimmer 15. Filter Lid (The filter cartridge and suction fitting/filter are located under the filter lid.) | <ol style="list-style-type: none"> 16. AquaTerrace Waterfall Control Valve 17. AquaTerrace Waterfall Filtration Return 18. Fluidix ST Jets (12 ea.) 19. AquaTerrace Waterfalls (2 ea.) 20. Pulsator Jets (6 ea.) 21. Optional BLUEWAVE® Spa Stereo System 22. Optional Audio System Speakers (6 ea.) 23. Sunscents™ Dispenser 24. Vortex Jets (7 ea.) 25. Integrated cupholders (4 ea.) 26. Fluidix Reflex Jets (6 ea.) 27. Focus-Relief Jets (8 ea.) |
|--|---|

Spa features subject to change without notice.

9.4 Maxxus Massage/Waterfall Selector Diagram

Massage Selector Operation

Rotate Massage Selectors 1 and 2 to divert water between designated jet groups.

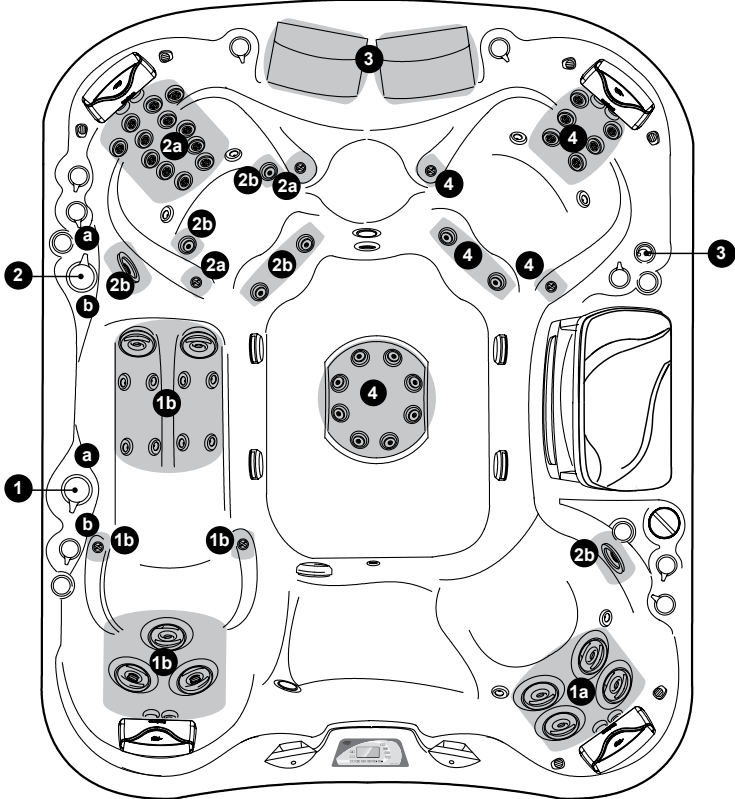

Massage Selectors (1-2)

- Massage Selector #1 controls pump #2.
- Massage Selector #2 controls pump #3.

Waterfall Selector (3)

- Waterfall Selector #3 controls circulation pump output to waterfall.

Continuously Powered Jets (4)

- Jets #4 are always on when jets pump #1 is running.

Spa operation subject to change without notice.

9.5 Maxxus Air Controls Diagram

Air Control Operation

Rotate Air Controls 1-8 to add air to designated jet groups.
Turn the Blower on to add air to jets group 9.

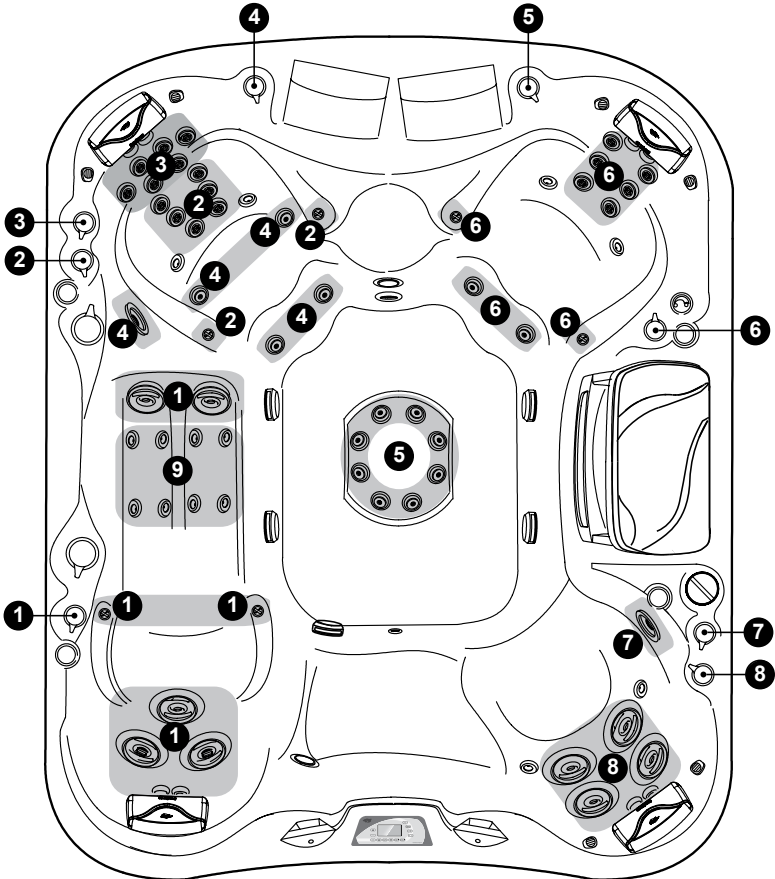

9.6 Aspen Hot Tub Features

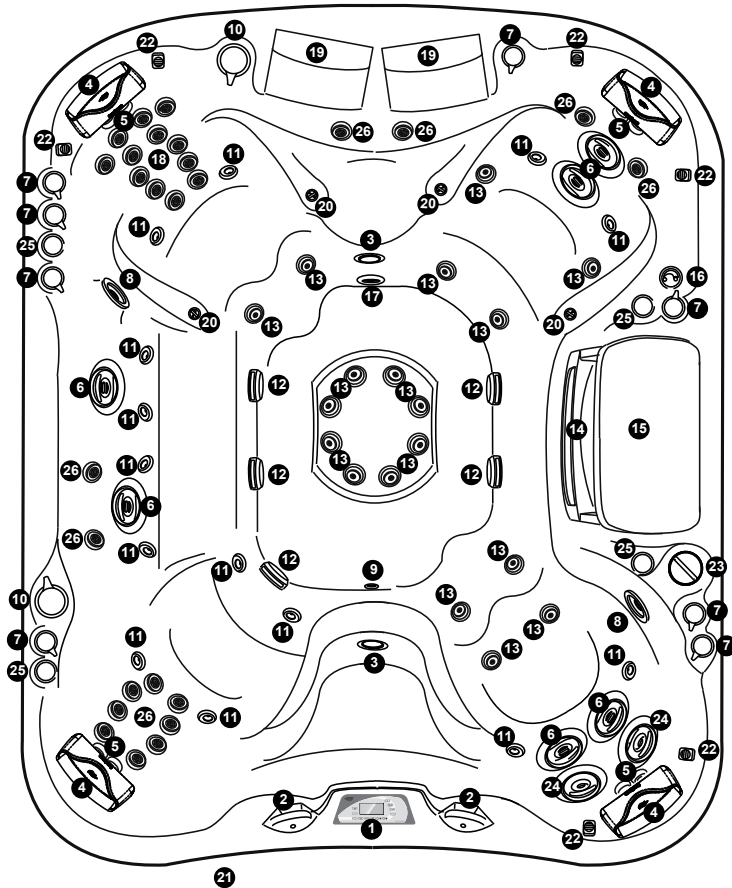

- | | |
|--|---|
| <ol style="list-style-type: none"> 1. Main Control Panel 2. Handrails with LED Light (2 ea.) 3. Lights (2 ea.) 4. Pillows (4 ea.) 5. Fluidix Nex Jets (8 ea.) 6. Fluidix Intelli-Jets (6 ea.) 7. Air Controls with LED Light (8 ea.) 8. Whirlpool Jets (2 ea.) 9. Gravity Drain 10. Massage Selectors (2 ea.) 11. Air Injectors (14 ea.) 12. Suction Covers (6 ea.; one is not shown) 13. Accu-Pressure Jets (18 ea.) 14. Weir Gate/Skimmer 15. Filter Lid (The filter cartridge and suction fitting/filter are located under the filter lid. | <ol style="list-style-type: none"> 16. AquaTerrace Waterfall Control Valve 17. AquaTerrace Waterfall Filtration Return 18. Fluidix ST Jets (12 ea.) 19. AquaTerrace Waterfalls (2 ea.) 20. Pulsator Jets (4 ea.) 21. Optional BLUEWAVE® Spa Stereo System 22. Optional Audio System Speakers (6 ea.) 23. Sunscents™ Dispenser 24. Vortex Jets (2 ea.) 25. Integrated cupholders (4 ea.) 26. Fluidix Reflex Jets (14 ea.) <p>The suction fitting filter requires periodic cleaning for optimum performance)</p> |
|--|---|

Spa operation subject to change without notice.

9.7 Aspen Massage/Waterfall Selector Diagram

Massage Selector Operation

Rotate Massage Selectors 1 and 2 to divert water between designated jet groups.

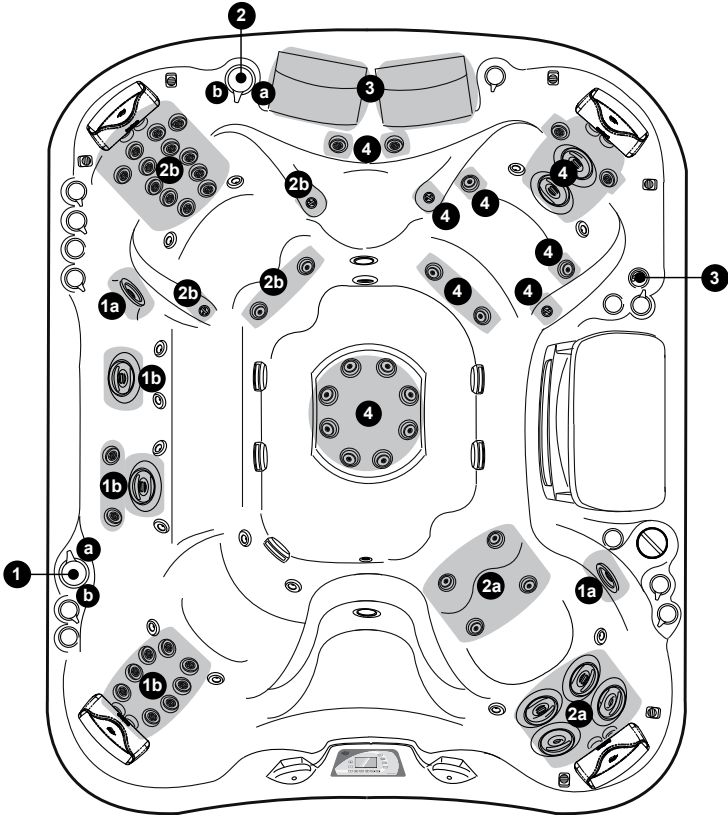

Massage Selectors (1-2)

- Massage Selector #1 controls pump #1.
- Massage Selector #2 controls pump #2.

Waterfall Selector (3)

- Waterfall Selector #3 controls circulation pump output to waterfall.

Continuously Powered Jets (4)

- Jets #4 are always on when jets pump #3 is running.

Spa features subject to change without notice.

9.8 Aspen Air Controls Diagram

Air Control Operation

Rotate Air Controls 1-8 to add air to designated jet groups.

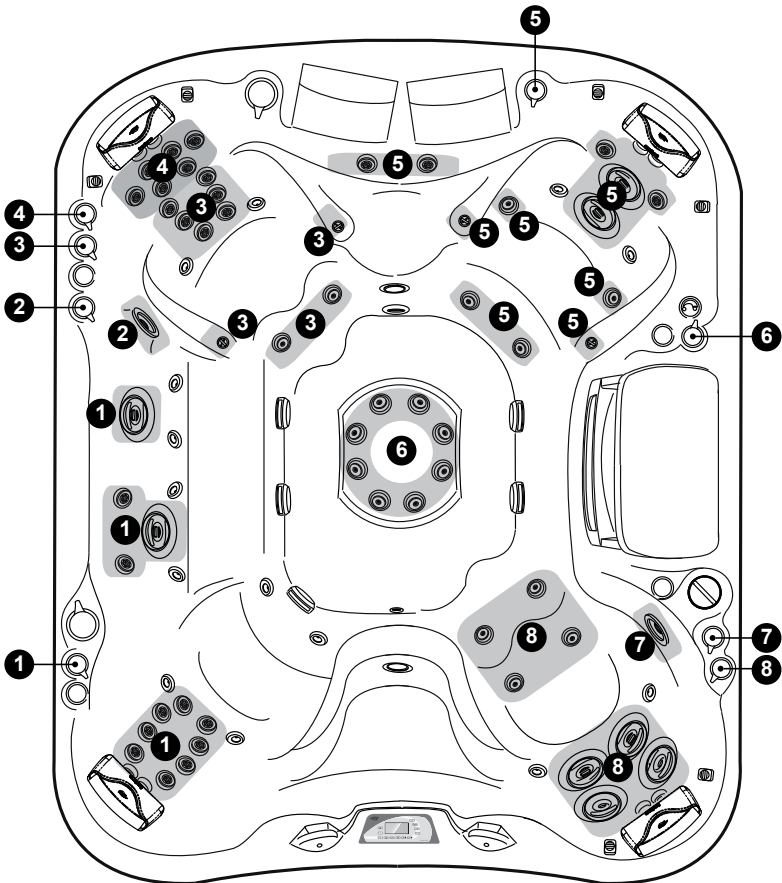

9.9 Optima® Hot Tub Features

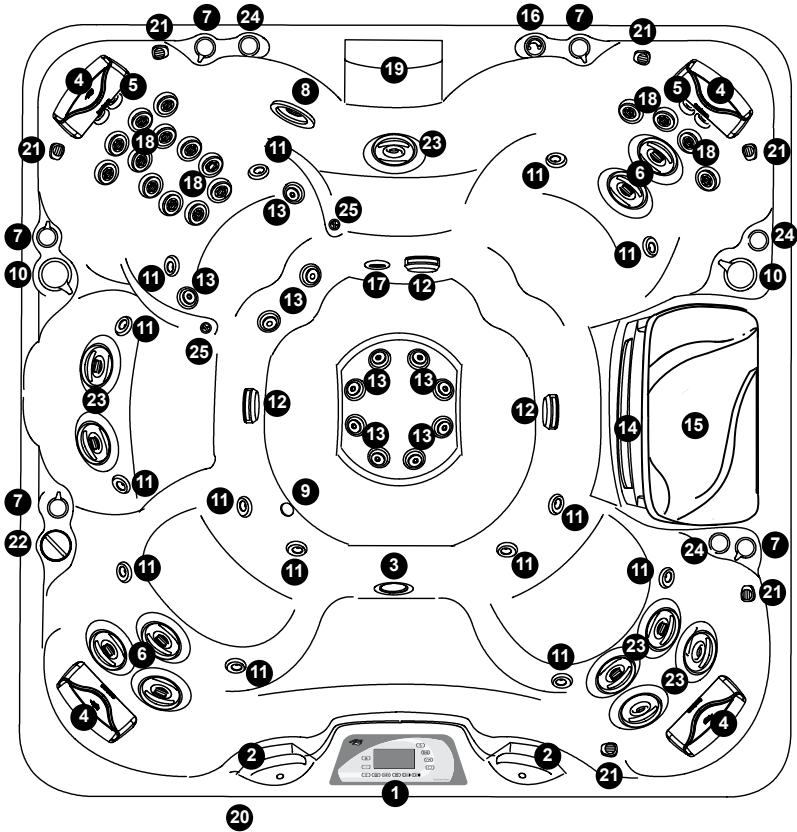

- | | |
|---|---|
| <ol style="list-style-type: none"> 1. Main Control Panel 2. Handrails with LED Light (2 ea.) 3. Light 4. Pillows (4 ea.) 5. Fluidix Nex (4 ea.) 6. Fluidix Intelli-Jets (5 ea.) 7. Air Controls with LED Light (5 ea.) 8. Whirlpool Jets (1 ea.) 9. Gravity Drain 10. Massage Selectors (2 ea.) 11. Air Injectors (14 ea.) 12. Suction Covers (4 ea.; one is not shown) 13. Accu-Pressure Jets (12 ea.) 14. Weir Gate/Skimmer | <ol style="list-style-type: none"> 15. Filter Lid (The filter cartridge and suction fitting/filter are located under the filter lid. The suction fitting filter requires periodic cleaning for optimum performance) 16. AquaTerrace Waterfall Control Valve 17. AquaTerrace Waterfall Filtration Return 18. Fluidix ST Jets (16 ea.) 19. AquaTerrace Waterfall 20. Optional BLUEWAVE® Spa Stereo System 21. Optional Audio System Speakers (6 ea.) 22. Sunscents Dispenser 23. Vortex Jets (7 ea.) 24. Integrated Cupholders (3 ea.) 25. Pulsator Jets (2 ea.) |
|---|---|

Spa features subject to change without notice.

9.10 Optima Massage/Waterfall Selector Diagram

Massage Selector Operation

Rotate Massage Selectors 1 and 2 to divert water between designated jet groups.

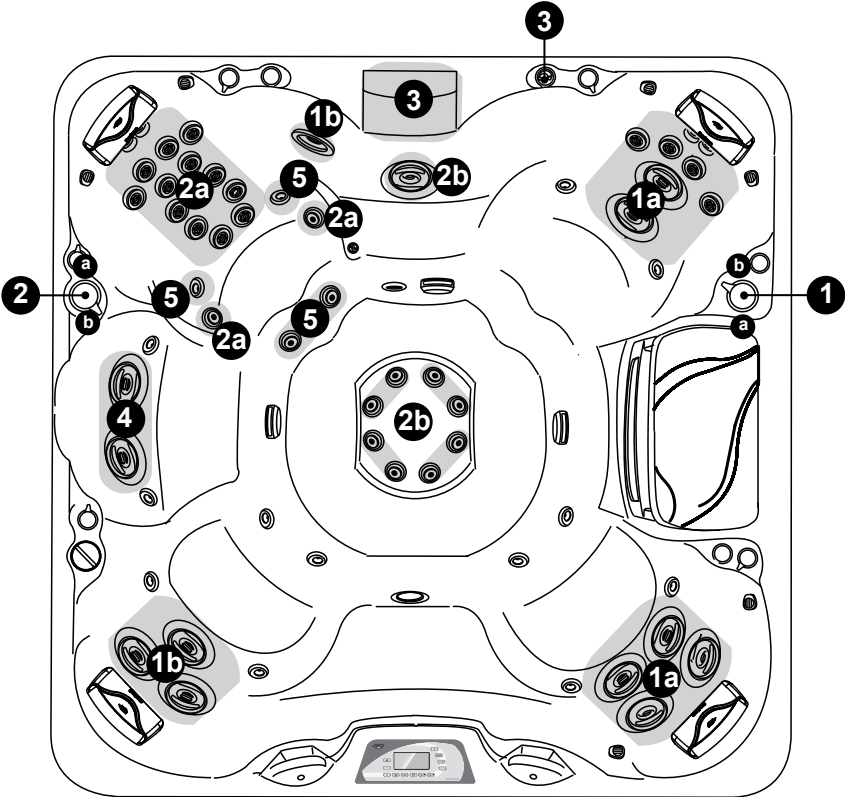

Massage Selectors (1-2)

- Massage Selector #1 controls pump #1.
- Massage Selector #2 controls pump #2.

Waterfall Selector (3)

- Waterfall Selector #3 controls circulation pump output to waterfall.

Continuously Powered Jets (4-5)

- Jets #4 are always on when jets pump #1 is running.
- Jets #5 are always on when jets pump #2 is running.

9.11 Optima Air Controls Diagram

Air Control Operation

Rotate Air Controls 1-5 to add air to designated jet groups.

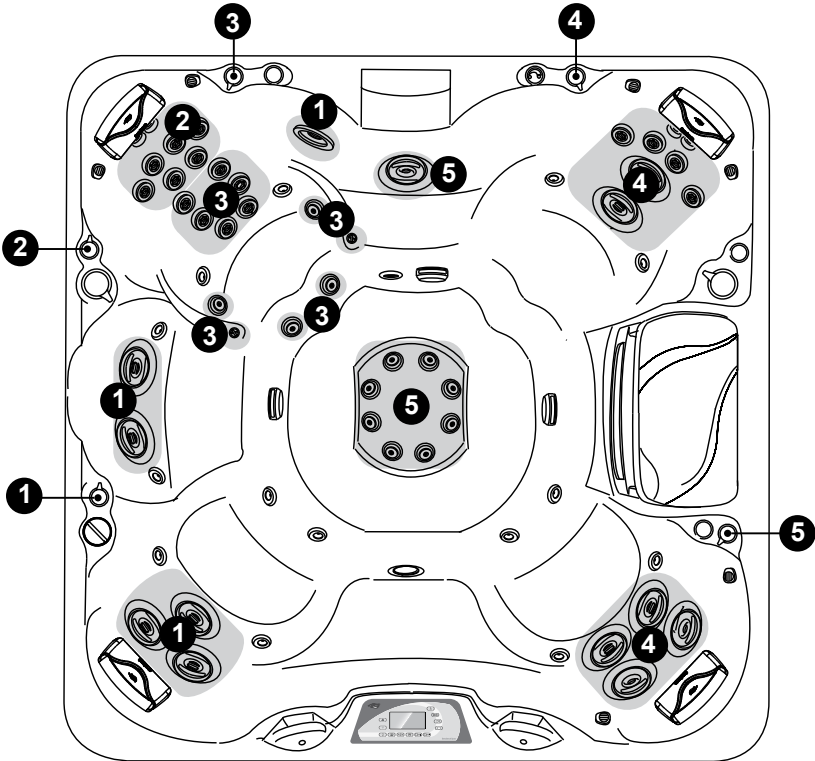

Spa operation subject to change without notice.

9.12 Cameo® Hot Tub Features

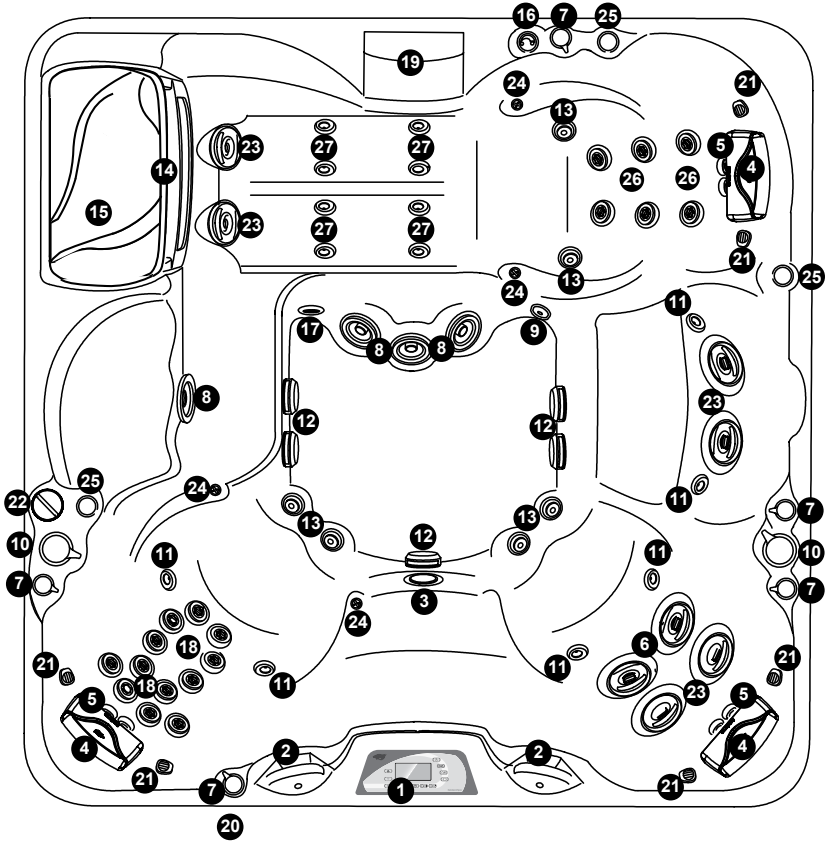

1. Control Panel
2. Handrails with LED Light (2 ea.)
3. Light
4. Pillows (3 ea.)
5. Fluidix Nex Jets (6 ea.)
6. Fluidix Intelli-Jets (2 ea.)
7. Air Controls with LED Light (5 ea.)
8. Whirlpool Jets (4 ea.)
9. Gravity Drain
10. Massage Selectors (2 ea.)
11. Air Injectors (6 ea.)
12. Suction Covers (6 ea.; one is not shown)
13. Accu-Pressure Jets (6 ea.)
14. Weir Gate/Skimmer
15. Filter Lid (The filter cartridge and suction fitting/filter are located under the filter lid.

16. AquaTerrace Waterfall Control Valve
17. AquaTerrace Waterfall Filtration Return
18. Fluidix ST Jets (12 ea.)
19. AquaTerrace Waterfall
20. Optional BLUEWAVE® Spa Stereo System
21. Optional Audio System Speakers (6 ea.)
22. Sunscents Dispenser
23. Vortex Jets (6 ea.)
24. Pulsator Jets (4 ea.)
25. Integrated Cupholders (3 ea.)
26. Fluidix Reflex Jets (6 ea.)
27. Focus-Relief Jets (8 ea.)

Spa features subject to change without notice.

9.13 Cameo Massage/Waterfall Selector Diagram

Massage Selector Operation

Rotate Massage Selectors 1 and 2 to divert water between designated jet groups.

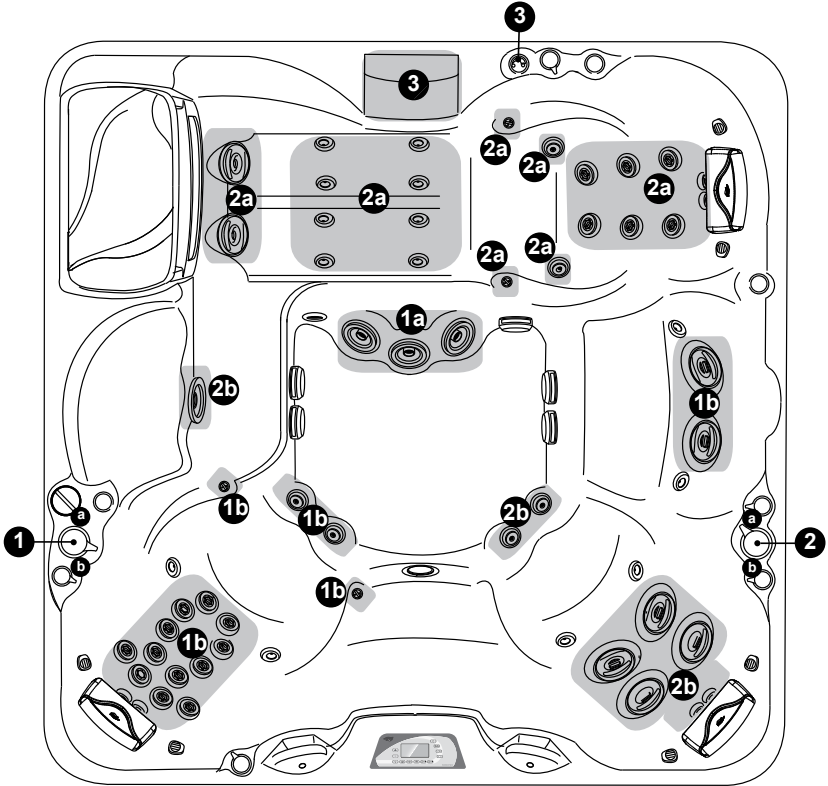

Massage Selectors (1-2)

- Massage Selector #1 controls pump #1.
- Massage Selector #2 controls pump #2.

Waterfall Selector (3)

- Waterfall Selector #3 controls circulation pump output to waterfall.

9.14 Cameo Air Controls Diagram

Air Control Operation

Rotate Air Controls 1-5 to add air to designated jet groups.

Turn the Blower on to add air to jets group 6.

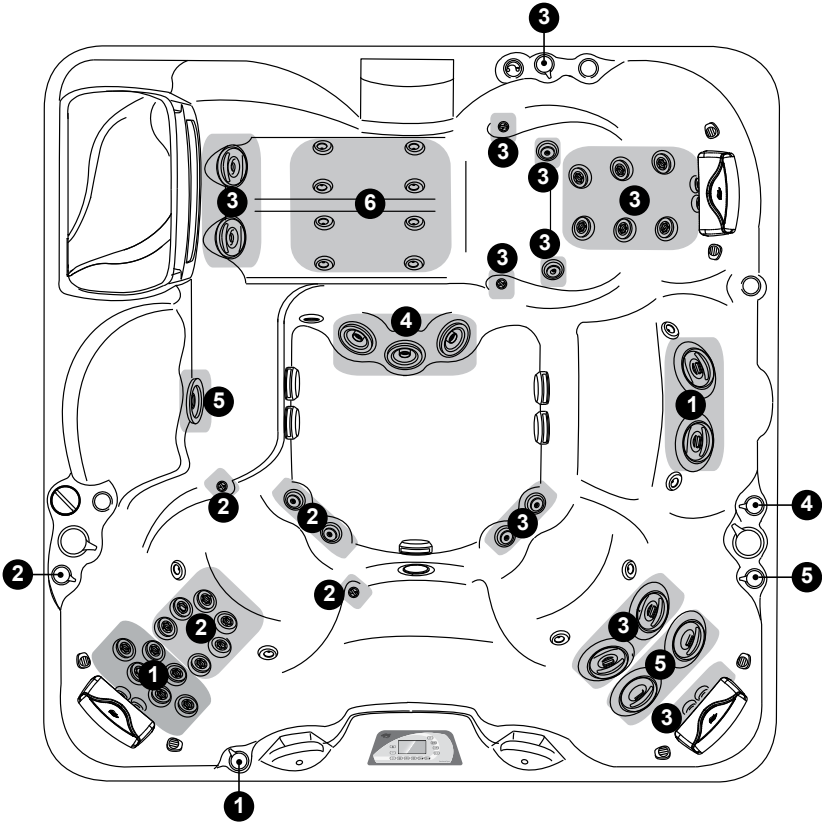

9.15 Altamar Hot Tub Features

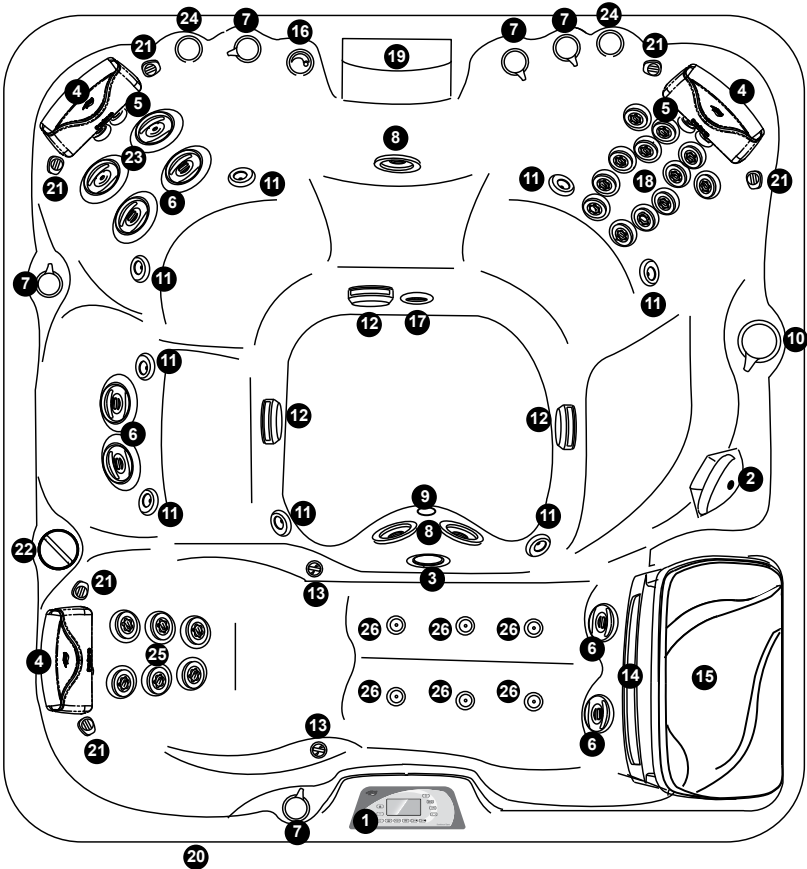

- | | |
|--|---|
| <ol style="list-style-type: none"> 1. Main Control Panel 2. Handrail with LED Light 3. Light 4. Pillows (3 ea.) 5. Fluidix Nex (4 ea.) 6. Fluidix Intelli-Jets (6 ea.) 7. Air Controls with LED Light (5 ea.) 8. Whirlpool Jets (3 ea.) 9. Gravity Drain 10. Massage Selectors 11. Air Injectors (8 ea.) 12. Suction Covers (4 ea.; one is not shown) 13. Pulsator Jets (2 ea.) 14. Weir Gate/Skimmer 15. Filter Lid (The filter cartridge and suction fitting/filter are located under the filter lid. | <ol style="list-style-type: none"> 16. AquaTerrace Waterfall Control Valve 17. AquaTerrace Waterfall Filtration Return 18. Fluidix ST Jets (12 ea.) 19. AquaTerrace Waterfall 20. Optional BLUEWAVE® Spa Stereo System 21. Optional Audio System Speakers (6 ea.) 22. Sunscents Dispenser 23. Vortex Jets (2 ea.) 24. Integrated Cupholders (2 ea.) 25. Fluidix Reflex (6 ea.) 26. Focus-Relief Jets (6 ea.) <p>The suction fitting filter requires periodic cleaning for optimum performance)</p> |
|--|---|

Spa features subject to change without notice.

9.16 Altamar Massage/Waterfall Selector Diagram

Massage Selector Operation

Rotate Massage Selector 1 to divert water between designated jet groups.

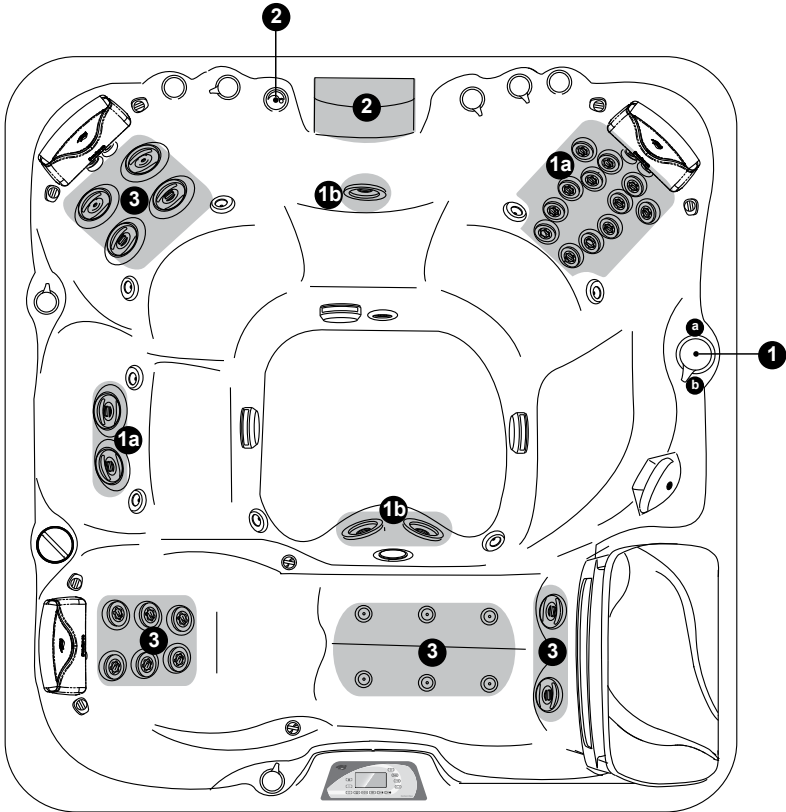

Massage Selectors (1)

- Massage Selector #1 controls pump #2.

Waterfall Selector (2)

- Waterfall Selector #2 controls circulation pump output to waterfall.

Continuously Powered Jets (3)

- Jets #3 are always on when jets pump #1 is running.

Spa operation subject to change without notice.

9.17 Altamar Air Controls Diagram

Air Control Operation

Rotate Air Controls 1-5 to add air to designated jet groups.

Turn the Blower on to add air to jets group 6.

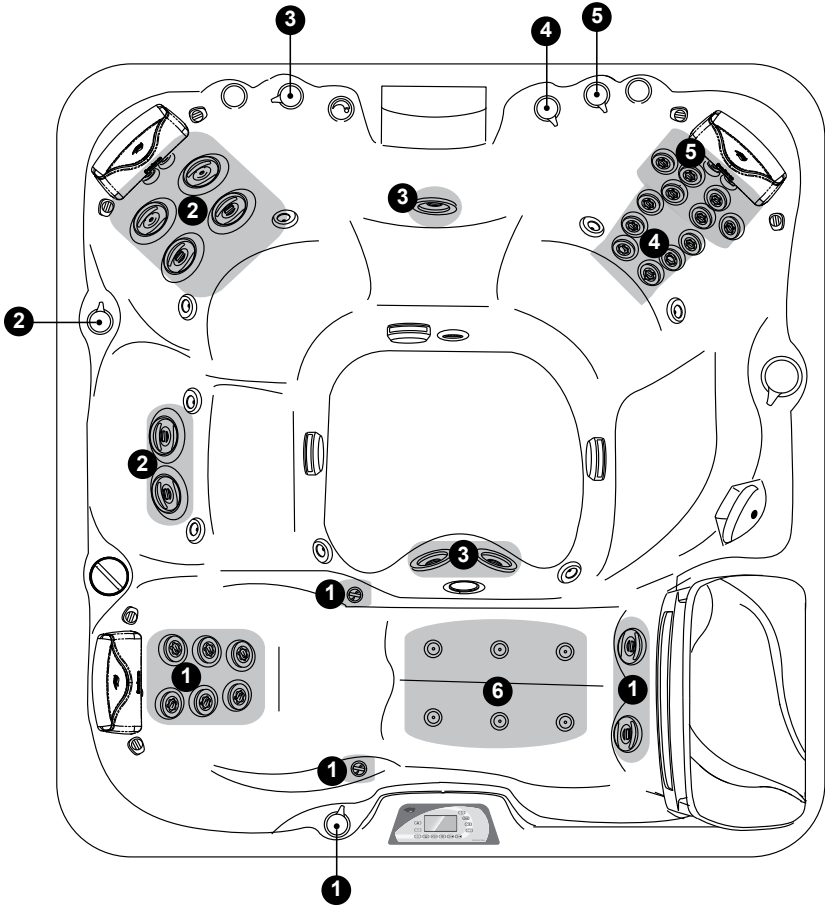

9.18 Majesta® Hot Tub Features

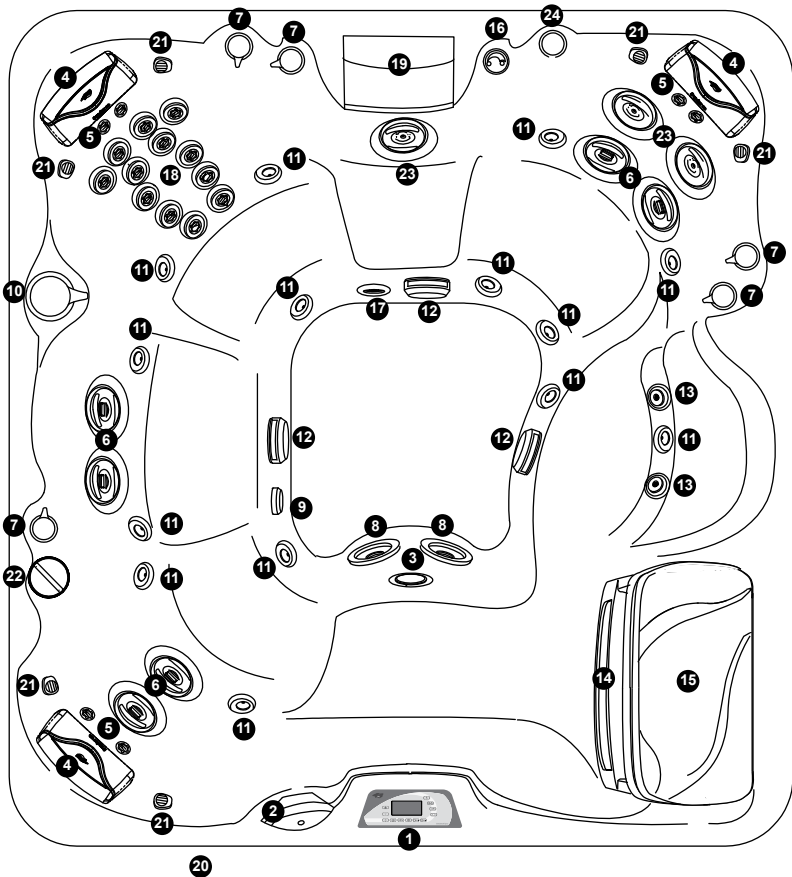

- | | |
|--|--|
| <ol style="list-style-type: none"> 1. Main Control Panel 2. Handrail with LED Light 3. Light 4. Pillows (3 ea.) 5. Fluidix Nex (6 ea.) 6. Fluidix Intelli-Jets (6 ea.) 7. Air Controls with LED Light (5 ea.) 8. Whirlpool Jets (2 ea.) 9. Gravity Drain 10. Massage Selector (1 ea.) 11. Air Injectors (14 ea.) 12. Suction Covers (4 ea.; one is not shown) 13. Accu-Pressure Jets (2 ea.) 14. Weir Gate/Skimmer | <ol style="list-style-type: none"> 15. Filter Lid (The filter cartridge and suction fitting/filter are located under the filter lid. The suction fitting filter requires periodic cleaning for optimum performance) 16. AquaTerrace Waterfall Control Valve 17. AquaTerrace Waterfall Filtration Return 18. Fluidix ST Jets (12 ea.) 19. AquaTerrace Waterfall 20. Optional BLUEWAVE® Spa Stereo System 21. Optional Audio System Speakers (6 ea.) 22. Sunscents Dispenser 23. Vortex Jets (3 ea.) 24. Integrated Cupholders (1 ea.) |
|--|--|

Spa features subject to change without notice.

9.19 Majesta Massage/Waterfall Selector Diagram

Massage Selector Operation

Rotate Massage Selector 1 to divert water between designated jet groups.

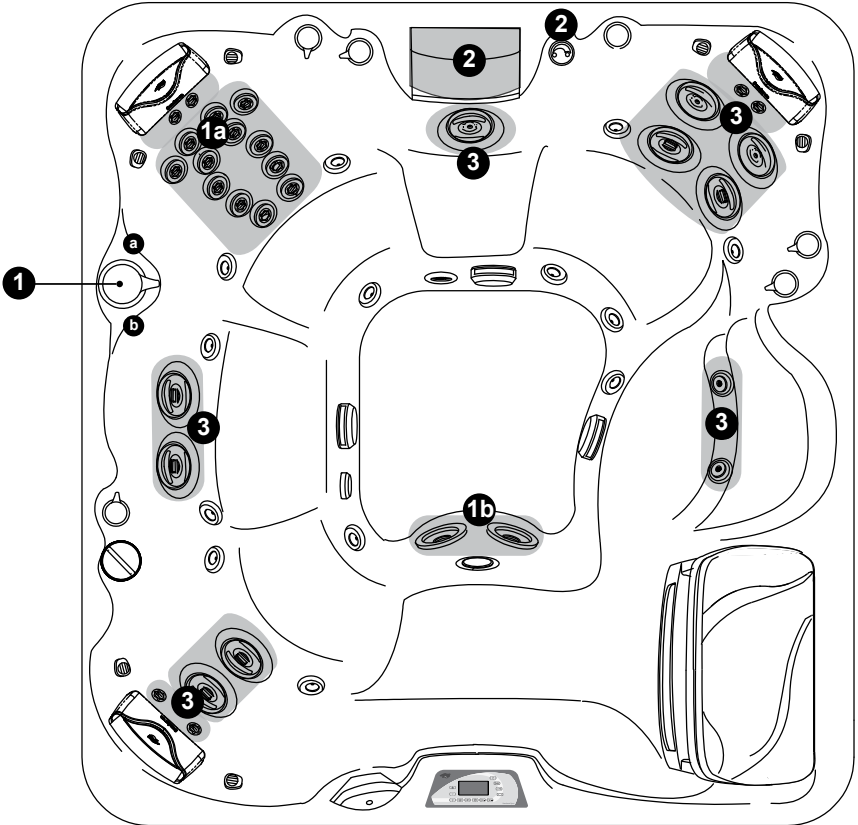

Massage Selectors (1)

- Massage Selector #1 controls pump #2.

Waterfall Selector (2)

- Waterfall Selector #2 controls circulation pump output to waterfall.

Continuously Powered Jets (3)

- Jets #3 are always on when jets pump #1 is running.

Spa operation subject to change without notice.

9.20 Majesta Air Controls Diagram

Air Control Operation

Rotate Air Controls 1-5 to add air to designated jet groups.

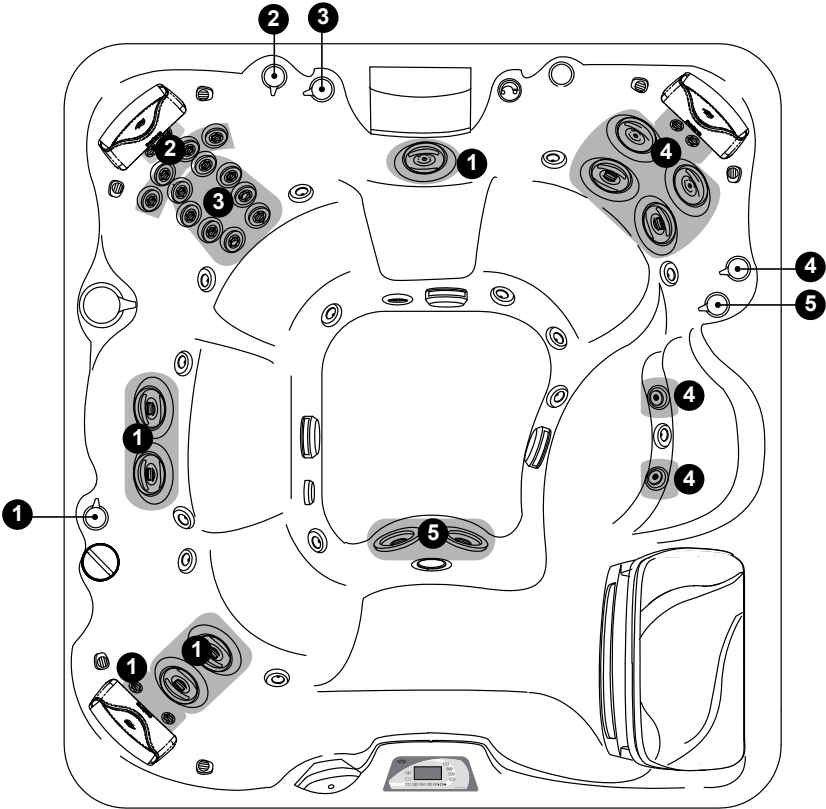

9.21 Marin Hot Tub Features

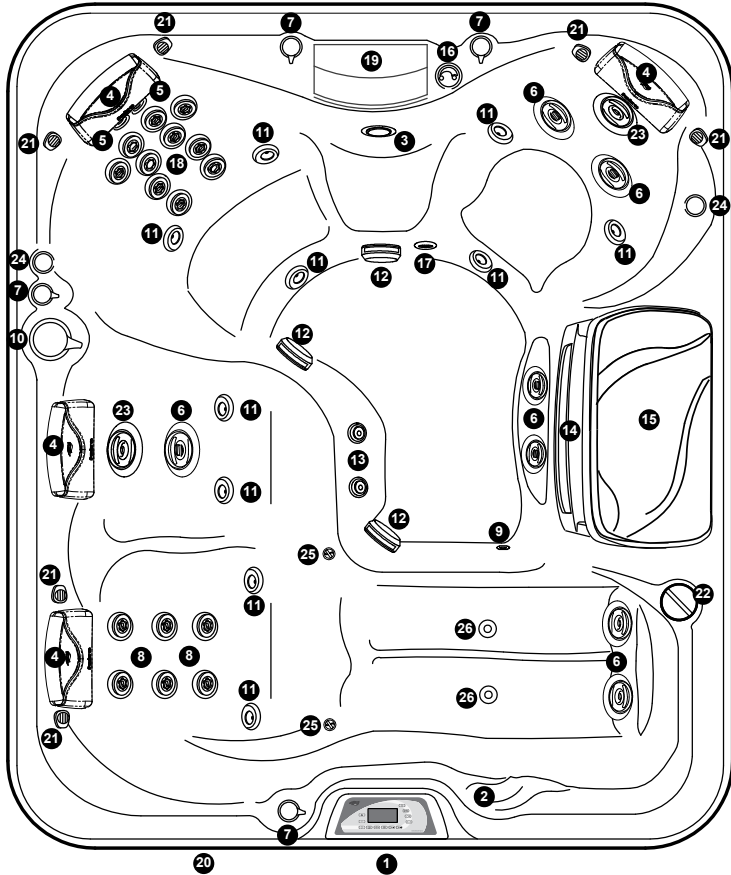

- | | |
|---|--|
| <ol style="list-style-type: none"> 1. Main Control Panel 2. Integrated Handrail 3. Light 4. Pillows (4 ea.) 5. Fluidix Nex (2 ea.) 6. Fluidix Intelli-Jets (7 ea.) 7. Air Controls with LED Light (4 ea.) 8. Fluidix Reflex Jets (6 ea.) 9. Gravity Drain 10. Massage Selector (1 ea.) 11. Air Injectors (10 ea.) 12. Suction Covers (4 ea.; one is not shown) 13. Accu-Pressure Jets (2 ea.) 14. Weir Gate/Skimmer 15. Filter Lid (The filter cartridge and suction | <ol style="list-style-type: none"> fitting/filter are located under the filter lid. The suction fitting filter requires periodic cleaning for optimum performance) 16. AquaTerrace Waterfall Control Valve 17. AquaTerrace Waterfall Filtration Return 18. Fluidix ST Jets (10 ea.) 19. AquaTerrace Waterfall 20. Optional BLUEWAVE® Spa Stereo System 21. Optional Audio System Speakers (6 ea.) 22. Sunscents Dispenser 23. Vortex Jets (2 ea.) 24. Integrated Cupholders (2 ea.) 25. Pulsator Jets (2 ea.) 26. Focus-Relief (2 ea.) |
|---|--|

Spa features subject to change without notice.

9.22 Marin Massage/Waterfall Selector Diagram

Massage Selector Operation

Rotate Massage Selector 1 to divert water between designated jet groups.

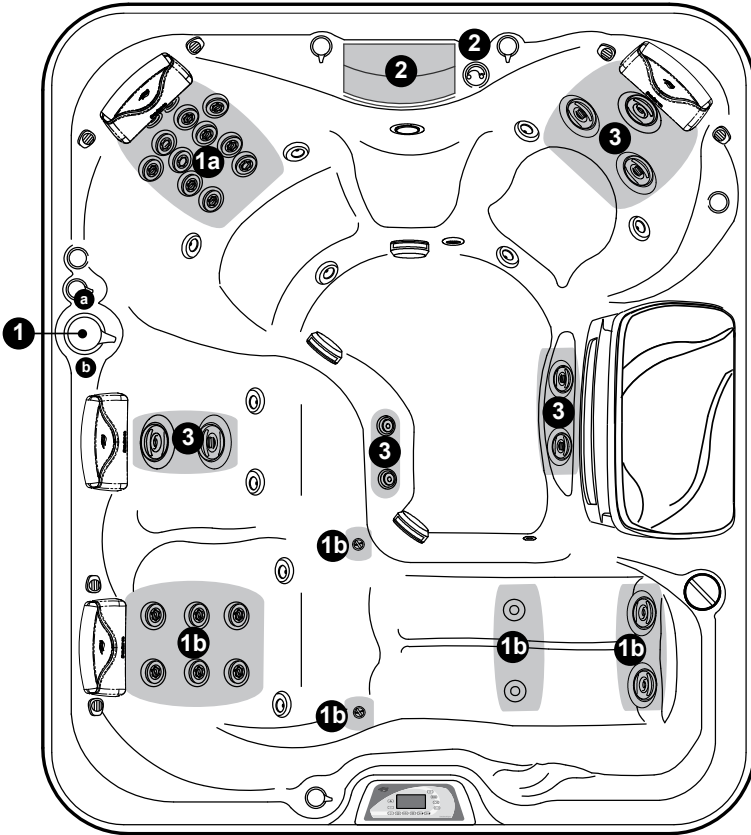

Massage Selectors (1)

- Massage Selector #1 controls pump #2.

Waterfall Selector (2)

- Waterfall Selector #2 controls circulation pump output to waterfall.

Continuously Powered Jets (3)

- Jets #3 are always on when jets pump #1 is running.

9.23 Marin Air Controls Diagram

Air Control Operation

Rotate Air Controls 1-4 to add air to designated jet groups.

Turn the Blower on to add air to jets group 5.

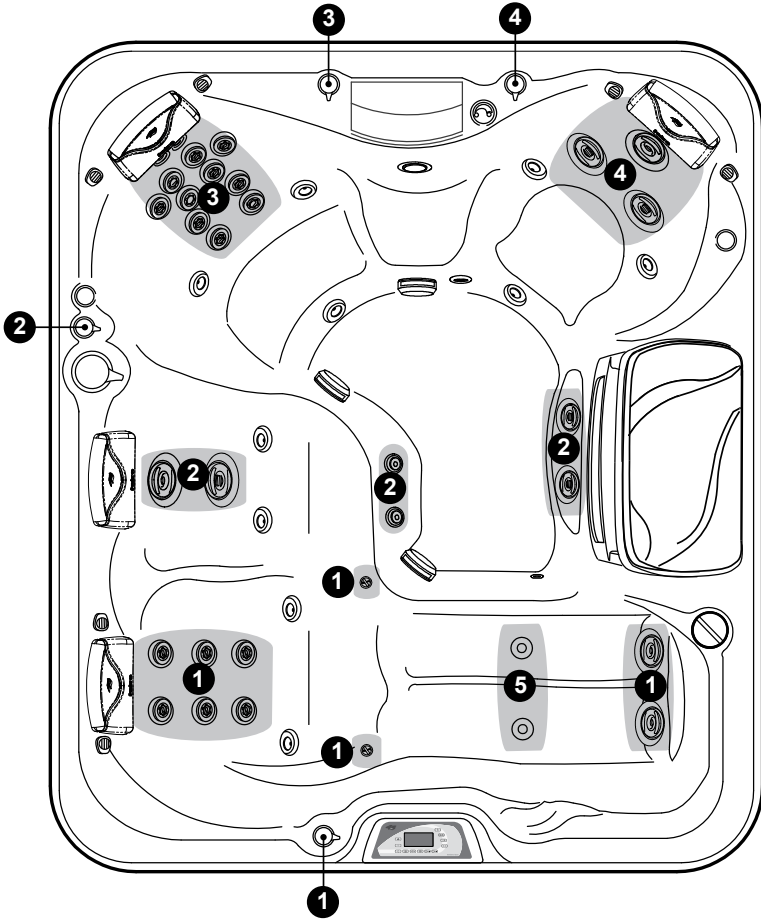

Spa operation subject to change without notice.

9.24 Capri® Hot Tub Features

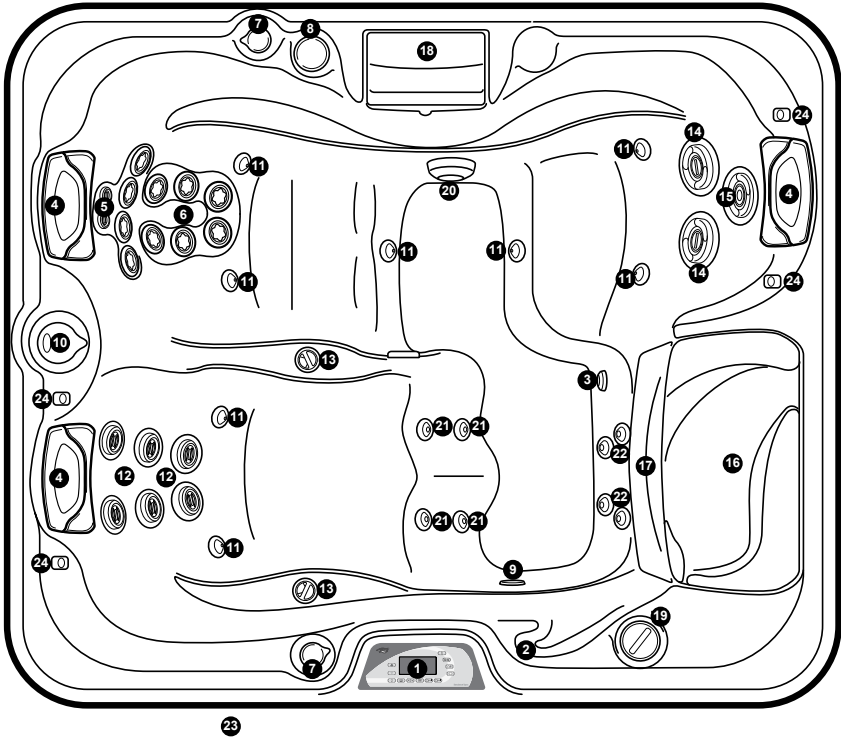

- | | |
|------------------------------------|---|
| 1. Control Panel | 16. Filter Lid (The filter cartridge and suction fitting/filter are located under the filter lid. The suction fitting requires periodic cleaning for optimum performance) |
| 2. Integrated Handrail | 17. Weir Gate/Skimmer |
| 3. Gravity Drain | 18. AquaTerrace Waterfall |
| 4. Pillows (3 ea.) | 19. SunScents Dispenser |
| 5. Fluidix Nex Jets (2 ea.) | 20. Footwell Suction Cover (2 ea. one is not shown) |
| 6. Fluidix ST Jets (10 ea.) | 21. Focus-Relief Jets (4 ea.) |
| 7. Air Controls (2 ea.) | 22. Accu-Pressure Jets (4 ea.) |
| 8. Waterfall Control Valve (1 ea.) | 23. Optional BLUEWAVE® Spa Stereo System |
| 9. Light | 24. Optional Audio System Speakers (4 ea.) |
| 10. Massage Selectors (1 ea.) | |
| 11. Air Injectors (10 ea.) | |
| 12. Fluidix Reflex Jets (6 ea.) | |
| 13. Pulsator Jets (2 ea.) | |
| 14. Fluidix Intelli-Jets (2 ea.) | |
| 15. Vortex Jet (1 ea.) | |

9.25 Capri Massage/Waterfall Selector Diagram

Massage Selector Operation

Rotate Massage Selector 1 to divert water between designated jet groups.

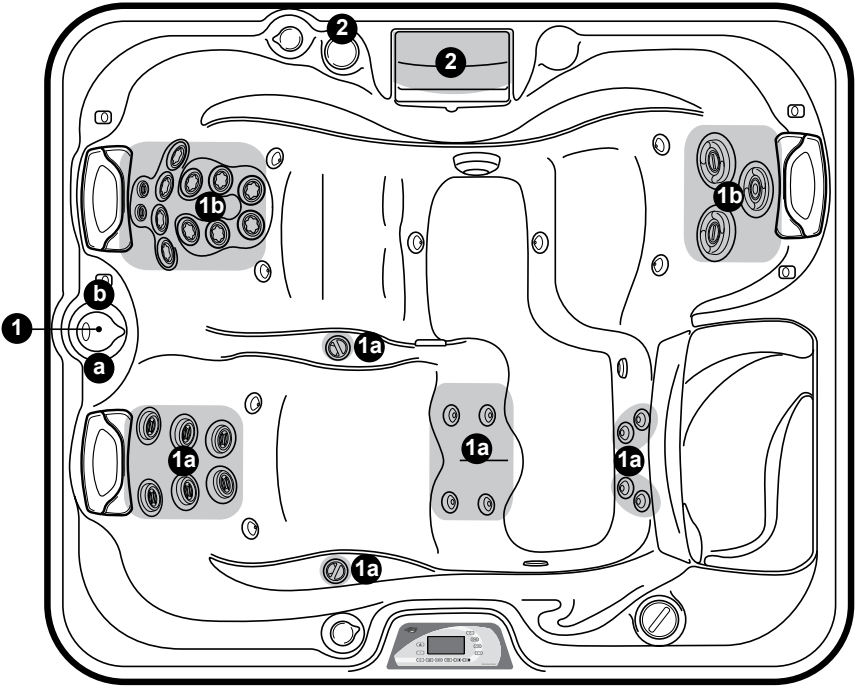

Massage Selectors (1)

- Massage Selector #1 controls pump #1.

Waterfall Selector (2)

- Waterfall Selector #2 controls circulation pump output to waterfall.

9.26 Capri Air Controls Diagram

Air Control Operation

Rotate Air Controls 1-2 to add air to designated jet groups.
Turn the Blower on to add air to jets group 3.

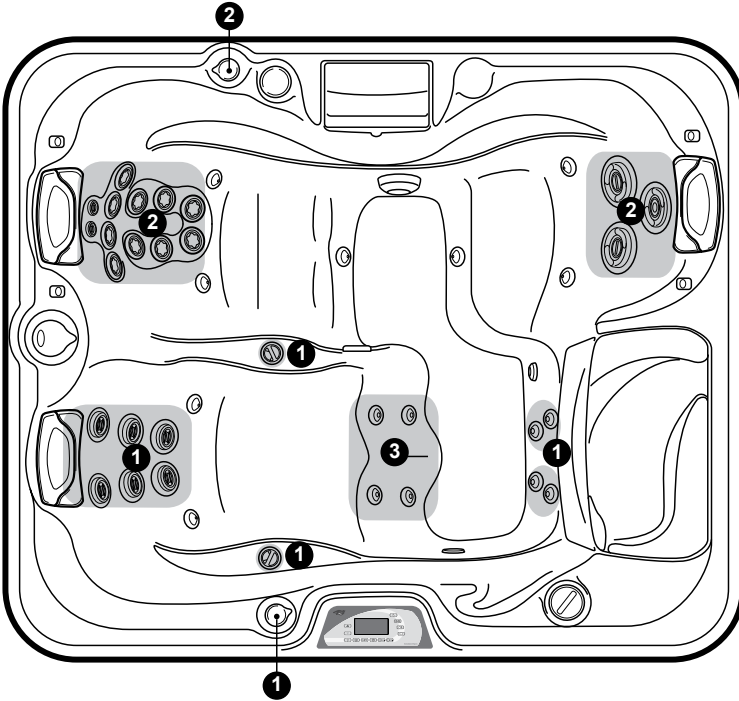

10.0 Operating Instructions

Your Sundance® hot tub has a touch-sensitive control panel, massage selector valves and air control knobs located on the top rim of the hot tub (Sections 9.3-9.24, pages 24-45). These controls let you operate many of the special functions of your Sundance hot tub. By familiarizing yourself with the following information, you will be able to gain the full benefit afforded by the various functions of your hot tub.



10.1 View Button

Pressing this button inverts the main four-digit display on the Command Center's LCD screen to allow easy reading from either inside or outside the hot tub. 

10.2 Air Injection

When the **AIR** button is pressed, the air blower forces air through the injectors and Focus-Relief Jets. The bubbles symbol on the button appears on the LCD whenever the air blower is on. An electronic timer automatically turns the air blower off 20 minutes after it was turned on. **Note:** The air blower automatically activates for 1 minute at the start of the clean-up cycle at 12:00 (Noon). This clears the lines of the air injector system to help ensure that all water is exposed to sanitizer. This cycle is non-programmable. 

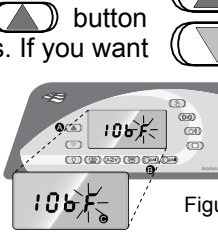

10.3 Controlling the water temperature

Press either the **(COOLER)**  or **(WARMER)**  button once to display the "set" temperature for 5 seconds. If you want the water to heat to a different temperature, simply press **COOLER** or **WARMER** within 5 seconds. The set temperature increases or decreases by one degree each time either button is pressed. To access the overtemp feature that allows the spa to reach 106°F (41°C) proceed with the following steps (Figure 1). Reference Section 3.0, page 2 for important safety instructions. 



WARNING: RISK OF HYPERTHERMIA (OVER-HEATING) CAUSING SEVERE INJURY, BURNS, WELTS OR DEATH!

Water temperature in excess of 104°F (40°C) may be injurious to your health.

- A. Press and hold the **WARMER** () button then;
- B. Press and hold the **JETS 1** () button at the same time for 2 seconds. You will see the temperature rise to 106°F (41°C) on the LCD display. To lower the temperature, press the **COOLER** () button.
- C. When the overtemp has been activated, the “F” after the last digit will flash on and off every second as an indicator for being in the overtemp mode.

Note: Once the temperature goes below 104°F (40°C) and you would like to raise the temperature to 106°F (41°C) again, you will have to repeat the steps above.

10.4 Activate Jets Pump 1

This button controls jets pump #1. Press once to turn on jets pump #1. Press a second time to turn pump off.



10.5 Activate Jets Pump 2/Pump 3

On two pump models, this button controls jets pump #2. Press once to turn on jets pump #2. Press a second time to turn pump off.
On three pump Maxxus/Aspen models, this button controls both jets pump #2 and jets pump #3 in the following sequence:



1. Press once to turn on jets pump #2.
2. Press a second time to turn on jets pump #3.
3. Press a third time to turn off jets pump #2.
4. Press a fourth time to turn off jets pump #3.

Note: Anytime a jet pump has been manually activated, it will automatically turn off after approximately 20 minutes. If at this time you desire more jet operation you may simply turn the pump(s) back on.

10.6 Light Button

Pressing this button activates the footwell, waterfall and air control LED lights in sequence as follows: High - Medium - Low - Off.

Note: Lights automatically turn off after 2 hours.

Anytime the light system has been manually activated, it will automatically turn off after approximately 2 hours. If at this time you desire more light operation, simply turn the light system back on.

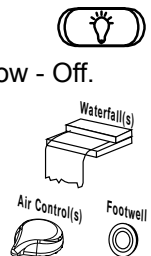

This button offers four light modes for your enjoyment. Press the LIGHT MODE button to select our favorite lighting effect as follows:



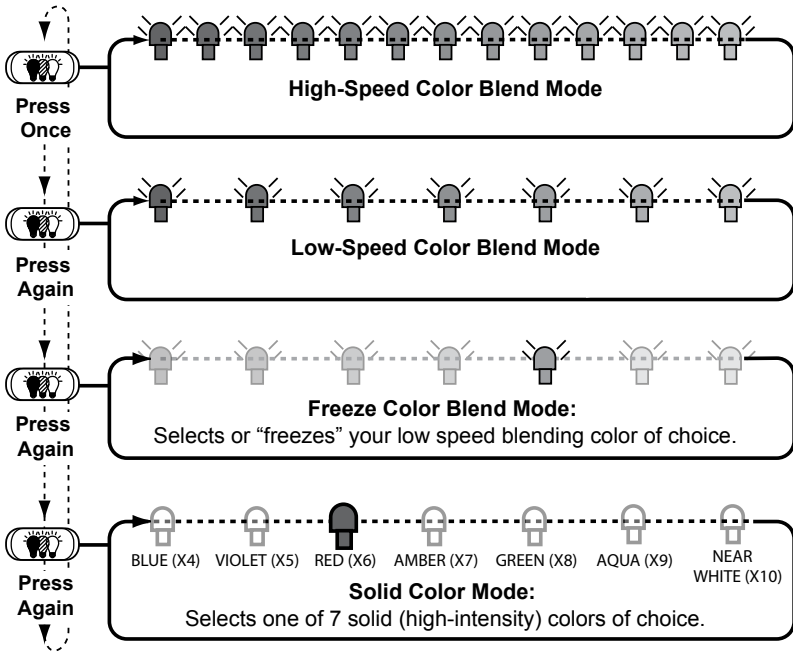

10.7 Selecting The Desired Massage Action

Your Sundance® hot tub is equipped to allow you to customize the massage action you desire. Each model incorporates a massage selector(s) that allows you to customize the massage and performance by diverting water between various jet systems. Simply turn massage selector to position A (Combo), B, or C to divert water pressure to various jet groups.



Note: This valve is designed to operate in positions A (Combo), B, and C for optimum performance. It is considered normal for sound levels within the valve to vary between positions due to the large amounts of water flowing through it. For optimum filtration benefits, leave the valve in position A when hot tub is covered. Select position B or C for maximum jet performance during hot tub use.

10.8 Adjusting Fluidix Reflex, Nex, ST, Intelli-Jets And Focus-Relief

These jets in your new hot tub offer the advantage of no moving parts and zero maintenance. They can also be adjusted for a high and low impact massage, providing the ultimate massage! To adjust jets:

1. Fluidix Nex/Intelli-Jets and Reflex Jets only: Turn outer dial (A) clockwise to increase water volume. Turn outer dial counterclockwise to decrease water volume or to shut jet off.
2. Fluidix Intelli-Jet only: Rotate center "mode disk" (B) clockwise to select a non-oscillating water stream or turn counterclockwise to select an oscillating stream at any angle.
3. For a high impact massage, turn corresponding air control knob clockwise. For the Fluidix ST jet, this will create a straight water flow. For low impact massage, turn corresponding air control knob counterclockwise. For the Fluidix ST jet, this will create an oscillating flow. Refer to Sections 9.3-9.24 (pages 24-45) for specific operation details. The included tool (shown) allows you to position the jet nozzle angle to your liking. This tool can also be used to aid in the opening or closing of the nozzle on Fluidix Reflex jets.
4. Focus-Relief Jets: Work with both the blower and jets pump. The blower introduces air to the jet and the jets pump forces water through.



Fluidix Intelli-Jet



Fluidix Reflex Jet



Fluidix ST Jet



Focus-Relief Jet

Note: Always keep at least 6 adjustable jets open at all times on each jet system.

10.9 Air Controls

Each jet system has its own air control. These controls allow you to regulate the amount of air which is mixed with the water entering through the jets. Clockwise rotation adds more air and counterclockwise rotation reduces air flow.



Note: To minimize heat loss, close all air controls when spa is not in use. Certain jets may draw air even though they are closed. This is considered normal.

10.10 Waterfall Control

Turn waterfall control valve counterclockwise to increase waterfall(s) output. Turn control valve clockwise to decrease or turn off waterfall(s) output. The waterfall is on when the circulation pump is running.

Note: It takes 2 full revolutions to change the waterfall from a full off to a full on flow rate. When the waterfall is in the OFF position some water may still flow through. This is considered normal.

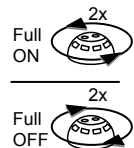

10.11 Fragrance Dispenser

On the rim of your hot tub is a screw-off cap labeled “SunScents™ Fragrance Dispenser” (pages 24-45). It is designed to contain packages of a specially made fragrance available from your Sundance Spas dealer. The fragrance is carried into the hot tub water by the air coming through the injector system when the air blower is on.



WARNING: TO DECREASE RISK OF PERSONAL INJURY.

- Always turn off the air blower before removing or installing SunScents dispenser cap to reduce the risk of by having the dispenser and/or cap fly up.
- Use only Sundance SunScents fragrances in your new hot tub, as the tub has not been tested for use with any other manufacturer. Never use this dispenser for any other type of fragrance.
- Never remove the SunScents beads from their plastic cage for any reason! This can cause damage to the spa equipment and plumbing lines.
- **The beads can also be ingested creating a choking or poisoning hazard. Keep away from children.**
- Install bead cage directly into SunScents dispenser.
- **Always make certain that the dispenser cap is securely in place before operating the hot tub’s air blower, to avoid the cap from flying off when the blower is activated.**

10.12 Indicator Light

The indicator light located on the front cabinet panel of the hot tub is an early detection system that will notify you when the hot tub needs immediate attention. A solid white light indicates that all operations are normal. A solid red light indicates that immediate attention is required to clear or fix an error code. For a detailed explanation refer to Section 15.0, page 74.



10.13 Optional BLUEWAVE® Spa Stereo System

Sundance models with the optional audio system offer enhanced hot tub enjoyment by offering an integrated state-of-the-art audio system. These models include an integrated FM/Apple Device/USB/AUX/Bluetooth Player receiver, high fidelity spa engineered speakers for unsurpassed sound quality and long-life.

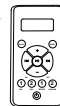

Note: The DRM (Digital Rights Management) Files cannot be played on this deck. Personal files (MP3, WMA, iTunes or AAC) can be played as long as they are not DRM encrypted.

11.0 Heating Modes

The control system in your hot tub activates a programmable “Standard” or “Economy” mode which effects when the heater operates. Refer to Sections 11.1 and 11.2 below for additional information.

11.1 Standard Mode (Factory Default)

Standard mode is typically selected by customers in cold climates where heat up times are extended due to lower ambient temperatures. In this mode, water temperature is regulated by the set temperature which activates the heater automatically as needed.

11.2 Economy Mode

Economy mode is typically selected by customers in warm climates where heat up times are minimized due to higher ambient temperatures. In this mode, the water temperature is regulated by the set temperature only when a programmed filter cycle is running.

11.3 Selecting Standard or Economy Mode

Press the **(MODE)**  button to select either “Standard” or “Economy” mode. The control panel’s indicator on the right side of the LCD changes to indicate which mode is selected.

Note: “Standard” is shown when Standard Mode is selected. No display is shown when Economy Mode is selected.

11.4 Clean-Up “Blow-Out” Cycle

The clean-up cycle is once per day in both Standard and Economy modes at 12:00 (noon) for two minutes. This is not user programmable.

- Maxxus and Aspen Models: Jets pump 3 and blower activate for approximately 45 seconds to circulate any water in the plumbing. Pump 3 shuts off, then pump 2 and the blower activate for approximately 45 seconds, then shut off. Finally, pump 1 activates and runs for approximately 30 seconds, then shuts off.
- Altamar/Cameo/Majesta/Marin/Optima Models: Jets pump 2 and blower activate for one minute to circulate any water in the plumbing. After 1 minute, pump 2 and blower shut off and jets pump 1 activates for 1 minute, then shuts off.
- Capri Models: The blower activates for one minute to circulate any water in the plumbing. After 1 minute, the blower shuts off and jets pump 1 activates for 1 minute, then shuts off.



12.0 Programming Instructions

12.1 Programming Filter/Circulation Pump

The control system allows you to easily adjust two separate aspects of filter/circulation pump operation:

- The time of day (start time) the filter/circulation pump turns on.
- The length of time (duration) the filter/circulation pump operates.

The factory default start time is 12:00AM (midnight). The recommended factory duration is 8 hours. To make adjustments:

- Standard Mode - in this mode, press the **(CYCLE)**  button once;
- Economy Mode - in this mode, press the **(CYCLE)**  button five times to enter the filter/circulation pump programming mode.







Note:

- Any time the circulation pump runs (e.g. when heating) outside of a programmed cycle, that run time will reduce the length of the next cycle.
- A mandatory cycle runs from 9am-11am only when the spa is in summer logic.



In extreme bitter cold weather we recommend you program the circulation pump to run 24 hours. Refer to the “Winterizing” section on page 66.

The LCD screen will display “Circ.” At this time the system is ready to accept your changes.

1. Press the **(SELECT)**  button once. The previously programmed start time appears on the LCD display.
2. Press the **(UP)**  or **(DOWN)**  button to adjust the start time in 30-minute increments.
3. Press the **(SELECT)**  button to program duration.
4. Press the **(UP)**  or **(DOWN)**  button to program the duration time in 1 hour increments.
5. Press the **(DISPLAY)**  button to save changes and recall the main water temperature display.

Note: If no button is pressed within 30 seconds, all changes are recorded and the screen automatically returns to the standard water temperature display. When the standard mode is selected (Section 11.3), the filter/circulation pump automatically turns on for a heat call regardless of the pump’s programmed start time and duration.

12.2 Programmable Filter/Heating Cycles (Economy Mode Only)



Your hot tub comes with four 30-minute filter/heater cycles which activate the filter/circulation pump while in economy mode. These cycles are factory programmed to start at 6:00 AM, 12:00 (noon), 6:00 PM, and 12:00 (midnight). The control system allows you to easily adjust two separate aspects of each cycle:

- The time of day at which it begins;
- The duration of the cycle.

Note: When “Economy” mode is selected (Section 11.3), the heater activates only during a programmed filter cycle period. When a Summer Logic condition is active (page 55), the filter/circulation pump will turn on for all programmed filter cycles.

Summer Logic: In warm weather, the water temperature in the hot tub may exceed the set temperature. This condition may occur due to heat transference from the filter/circulation pump and jets pumps. If the water temperature is higher than 95°F (35°C) and rises two degrees above the set temperature, a “Summer Logic” condition occurs that deactivates the filter/circulation pump and CLEARRAY®. This safety feature cannot be altered! The filter/circulation pump and CLEARRAY® will remain off until the water temperature cools to the set temperature. A mandatory cycle runs from 9am-11am only when the spa is in summer logic.



Note: Pressing the select button at this time will reactivate the circulation pump and waterfall feature for 1 hour. To help prevent a “Summer Logic” condition, it may be necessary to reduce filter/circulation pump cycle run times in warm weather.

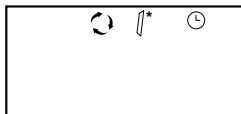





Press the **(MODE)**  button to select “Economy” mode. To make adjustments, first press the **(CYCLE)**  button to enter the filter cycle programming mode. The LCD screen will display the following in the upper right corner:



***Note:** Number will vary according to which filter cycle is being programmed.

This means the system is ready to accept your changes to the start time for cycle number one. Simultaneously, the large four-digit display in the center of the screen displays the currently programmed start time for that cycle. At this point, you have four options. You may:

1. Press **(UP)**  or **(DOWN)**  button to adjust the start time in increments of 30 minutes.



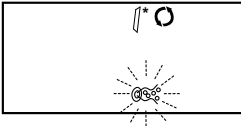

2. Press **(CYCLE)**  button to display and adjust each subsequent cycles start time. With each press, the currently programmed status will be shown in the large four digit display. To adjust any displayed value, simply press the **(UP)**  or **(DOWN)**  button.
3. Press **(SELECT)**  button to move down the menu from Start Time to Duration, with each press, the currently programmed duration will be shown in the large four-digit display. Press **(UP)**  or **(DOWN)**  button to adjust the duration in increments of 15 minutes.
4. Press **(DISPLAY)**  button to save changes and recall the main water temperature display.

Note: If no button is pressed within 30 seconds, all changes are recorded and the screen automatically returns to the standard water temperature display.









When a programmed filter/heating cycle activates, the LCD screen displays the following message:







***Note:** Number will vary according to which filter cycle is being programmed.













At any time, you may check the programming of any economy mode filter/heating cycle by first pressing **(CYCLE)**  button then moving through the menu by pressing either **(CYCLE)**  or **(SELECT)**  button. The programming is changed only by pressing **(UP)**  or **(DOWN)**  buttons during this process.

12.3 Adjusting Time of Day

The control system remembers the time of day even in the event of a prolonged power outage. However, it may occasionally be necessary to reset the time of day. To accomplish this, press **(DISPLAY)** , **(MODE)** , and **(DISPLAY)**  button within five seconds each. A number representing the hour will be displayed, followed by AM or PM. The hour will advance or decrease each time the **(UP)**  or **(DOWN)**  button is pressed within five seconds. Then, press the **(DISPLAY)**  button again to display minutes. Adjust minutes as necessary by pressing the **(UP)**  or **(DOWN)**  button. After 5 seconds, the display will return to normal and save your settings.

12.4 Programming The Date









The control system allows you program the month, day, year, and day of the week. To accomplish this, press **(DISPLAY)** , **(MODE)** , and **(DISPLAY)**  button within five seconds each. The current hour setting will be displayed, followed by AM or PM. Then, press the **(DISPLAY)**  button again to display minutes. Press the

(**DISPLAY**)  button again to adjust the month as necessary by pressing the (**UP**)  or (**DOWN**)  button. Press the (**DISPLAY**)  button again to adjust the day by pressing the (**UP**)  or (**DOWN**)  button. Press the (**DISPLAY**)  button again to adjust the year by pressing the (**UP**)  or (**DOWN**)  button. Press the (**DISPLAY**)  button again to adjust the day of the week by pressing the (**UP**)  or (**DOWN**)  button. After 5 seconds, the display will return to normal and save your settings.

Note: The day of the week will be represented by a number rather than by name. The numbers will run consecutively from 1-7 with 1 = Sunday and 7 = Saturday.













12.5 Main Control Panel Lock

To help prevent unauthorized use of your hot tub, the controls incorporate a unique panel locking system which disables the controls on the panel.

- To Lock The Main Control Panel: Press (**DISPLAY**) , (**MODE**) , and (**UP**)  buttons within five seconds each other. A padlock symbol will appear on the LCD screen. With the panel locked, all components are disabled from manual activation and the only settings that can be adjusted are the standard and economy filter/heating modes and time of day. All automatic hot tub functions will operate normally. 
- To Unlock Main Control Panel: Press (**DISPLAY**) , (**MODE**) , and (**DOWN**)  buttons within five seconds. The lock symbol will disappear. All buttons are now active. 

12.6 Temperature Setting Lock

The hot tub's temperature setting can be locked to prevent unauthorized changes. When locked, all other hot tub buttons and functions operate normally.

- To Lock Temperature Setting: Press (**UP**)  or (**DOWN**)  button to display temperature setting, then immediately press the (**DISPLAY**) , (**MODE**) , and (**UP**)  buttons within five seconds each. A padlock symbol will appear on the screen. 
- To Unlock Temperature Setting: Press (**UP**)  or (**DOWN**)  button to display temperature setting, then immediately press the (**DISPLAY**) , (**MODE**) , and (**DOWN**)  buttons within five seconds. 





12.7 Programming the Change Filter Reminder



Your new hot tub is equipped with a programmable “Change Filter” reminder icon that flashes on the control panel display after a specified number of days. It is designed to remind you to perform routine filter system maintenance on a regular basis but does not affect hot tub operation in any way. The “Change Filter” reminder icon must be reset at each interval. It offers a selectable range from 10-120 days or can be disabled (turned off). We recommend an initial setting of 30 days (1 month) to remind you of this important maintenance step.

Note: This reminder must be reset at each filter inspection/replacement interval. Refer to Section 13.1 for filter replacement instructions.

Programming Instructions

1. Press the **(CYCLE)**  button two times in Standard Mode, six times in Economy Mode. The main display reads “FIL” indicating the “Change Filter” display program has been accessed.
2. Press **(SELECT)**  button once to display the currently programmed duration or to view days elapsed since last filter cleaning interval.
3. Press **(UP)**  or **(DOWN)**  button to change duration setting as follows: 0 - 10 - 20 - 30 - 40 - 50 - 60 - 70 - 80 - 90 - 100 - 110 - 120 - OFF.





Note: Selecting “0” forces the Change Filter reminder icon to stay on indefinitely.

4. Press **(DISPLAY)**  button once to save changes and return to the standard water temperature display.

Note: If no button is pressed within 30 seconds, all changes are recorded and the screen automatically returns to the standard water temperature display.



12.8 Programming the CLEARARRAY® (Ultraviolet) Water Purification System



To access the programming options follow the step below.



- Standard Mode - in this mode, press the **(CYCLE)**  button three times;
- Economy Mode - in this mode, press the **(CYCLE)**  button seven times to enter the programming mode.

The LCD screen will display “U.” At this time the system is ready to accept your changes.

1. Press the **(SELECT)**  button once. The current status of the CLEARARRAY System appears on the LCD display, either “ON” or “OFF.”

2. Press the **(UP)**  or **(DOWN)**  button to change the status of the CLEARRAY System from either “ON” to “OFF.”



Note: If the “OFF” option is selected, then there is no need to continue with the steps below. Selecting “OFF” disables the duration countdown timer. Press the **(CYCLE)**  then the **(DISPLAY)**  button to return to the water temperature display.

3. Press the **(SELECT)**  button to access the duration countdown timer.
4. Press the **(UP)**  button to program the duration countdown timer to 365 days. **If the timer is not at “0” pressing the “UP” button will not reset it.**

Note: You can only program the duration if the number of days is at “0” days or the LCD display is flashing “blb.” Pressing the **(UP)**  button at any other reading will not change it.

5. Press the **(DISPLAY)**  button to save changes and exit back to the water temperature display.

Note:

- Flashing “blb” message: When the time allotted has expired (365 days) the display screen will flash between the water temperature and “blb.” The indicator light located on the front cabinet panel of the spa will be lit red. At this time the UV bulb must be replaced, the quartz tube must be cleaned and the duration countdown timer needs to be reset.
- If the spa power is interrupted, the timer is not affected. The number of days remaining is stored in the memory and will continue to countdown once power is regained.
- If you press the **(UP)**  button to “ON” then press the **(DOWN)**  to “OFF” and press the **(UP)**  button to “ON” again, you will reset the timer back to 365 days.

13.0 Hot Tub Maintenance

Proper and regular maintenance of your hot tub will help it retain its beauty and performance. Your authorized Sundance Spas dealer can supply you with all the information, supplies, and accessory products you will need to accomplish this.



DANGER: RISK OF SEVERE INJURY OR DROWNING BY ENTRAPMENT!

- Keep hair, loose articles of clothing or hanging jewelry away from suction fittings, rotating jets or other moving components to avoid entrapment that could lead to drowning or severe injury.
- Never use the spa unless all suction guards, filter, filter lid, or skimmer assembly are installed to prevent body and/or hair entrapment.
- Never operate or use the spa if the filter, filter lid, or skimmer assembly are broken or any part of the skimmer assembly is missing. Please contact your dealer or nearest service center for service.
- The suction fittings and suction covers in this spa are sized to match the specific water flow created by the pump(s). If it is necessary to replace the suction fittings, suction covers or pump(s), be sure that the flow rates are compatible and are in compliance with the VGB Safety Act, page 2.
- Never replace a suction fitting or suction cover with one rated less than the flow rate marked on the original suction fitting. Using improper suction fittings or suction covers can create a body or hair suction entrapment hazard that may lead to drowning or severe injury.
- Owners must alert all spa users to the potential risk of Hair, Limb, Body, Evisceration (disembowelment), and Mechanical Entrapment, page 6.

13.1 Cleaning/Replacing the Filter Cartridge

A programmable “Change Filter” reminder icon flashes on the control panel display after a specified number days to remind you to perform routine maintenance on your filter system. This reminder must be reset at each interval. Refer to Section 12.7, for additional information and programming details.



Your Sundance hot tub is equipped with a two-stage MICROCLEAN® Ultra filter cartridge assembly under the filter lid (Sections 9.3-9.24 pages 24-45). Debris is filtered by the filter/circulation pump drawing water through the filter assembly 8 hours a day, 7 days a week (unless programmed otherwise). To ensure optimum performance, clean the outer pleated filter and center insert monthly. Then replace the center insert every 6 months, or as needed thereafter. Refer to procedure below for details.

All models include a suction cover filter (#6540-213) located directly under the MICROCLEAN® Ultra filter cartridge assembly that prevents debris from entering the hot tub plumbing when jets pump 1 is running. This filter should be cleaned every 2 months.



TO DECREASE RISK OF DEATH, DROWNING, OR ENTRAPMENT, ALWAYS TURN POWER TO THE HOT TUB OFF BEFORE REMOVING THE MICROCLEAN ULTRA FILTER ASSEMBLY!

Filter Cleaning/Replacement Procedure:

1



DANGER: TURN POWER TO SPA OFF! TO DECREASE RISK OF DEATH, DROWNING, OR ENTRAPMENT, NEVER OPERATE SPA WHEN FILTER IS NOT PROPERLY INSTALLED OR IF WEIR ASSEMBLY IS DAMAGED OR ALTERED!



2

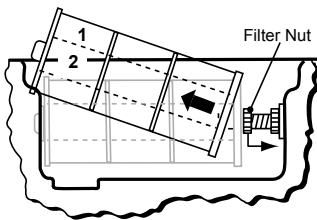

Filter Cleaning Requirements:

- Clean MICROCLEAN Ultra Pleated Filter (1) monthly and replace every 18 months (6473-165).
- Rinse off MICROCLEAN Ultra Insert (2) monthly and replace every 6 months or as needed (6473-164).

Filter Removal Instructions:

Loosen filter nut to provide clearance, then remove MICROCLEAN Ultra Filter Assembly from spa.

3

Monthly Filter Cleaning Procedure

We recommend cleaning the outer pleated filter (1) with a high pressure water nozzle and the filter insert (2) with a low-pressure water nozzle monthly. Periodically, the outer pleated filter cartridge (1) will require a more thorough cleaning to remove embedded oils and minerals by using special spa filter cleaners offered by your spa dealer. Always remove the center filter insert (2) before cleaning the outer filter (1) with chemicals. Never use filter cleaners of any kind on the filter insert (2) or it may be damaged, come apart or allow impurities to re-enter the water, increasing the risk of contracting a waterborne illness (e.g. an infection, bacteria or virus) and/or respiratory ailments.

Procedure:

1. Grasp center filter insert end cap (2) in hand and pull outward from pleated cartridge (1). If filter insert (2) is 6 months old, throw it away and purchase new one. DO NOT install new insert at this time.
2. Rinse debris from all outer filter (1) pleats using a garden hose and high-pressure nozzle. Repeat process until all filter pleats are clean. Then rinse debris from inside of filter (1). If chemical cleaners are used, follow manufacturers instructions.

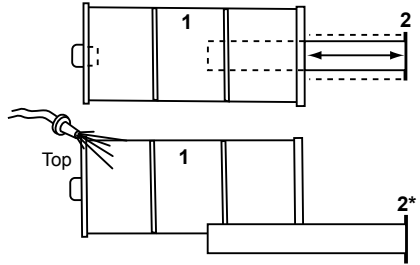

Lightly rise filter insert (2) and place in clean location. *DO

NOT use chemical cleaners or high-pressure nozzle on insert (2) or it may be damaged, come apart or allow impurities to re-enter the water, increasing the risk of contracting a waterborne illness (e.g. an infection bacteria or virus) and/or respiratory ailments.

3. Install filter insert (2) into outer pleated filter (1) by gently sliding inward until a slight resistance is felt approximately 1/4" from bottom. Lightly tap insert end with palm of hand to "snap" in place. Insert is properly installed when end cap rests "flush" against outer filter end cap.
4. Install Filter assembly back into spa by performing step 2 in reverse order. Tighten filter nut so it just touches the filter face. DO NOT OVERTIGHTEN!
5. Turn power to spa back on.

Replacement filter cartridges may be purchased from your Sundance Spas dealer.

13.2 Quick Release Door (Except Maxxus and Aspen Models)

The Quick Release Door provides easy access to the equipment bay and components without having to unscrew the panel. To remove the Quick Release Door follow the steps below:

1. Locate the two Quick Release Door buttons on the top corners of the center panel, Figure A.
2. Press the buttons to release the panel from the spa frame, Figure B.

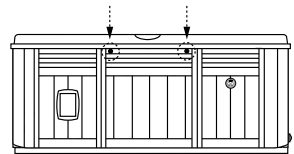

Figure A

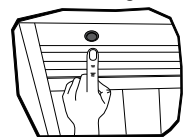

Figure B

3. Slowly and gently tilt the panel forward to remove. This will expose the equipment bay for easy access to components like the CLEARRAY System and the Quick Drain Valve, Figure C. Place the panel in a safe location to prevent from damaging it.
4. To reinstall the panel just follow the steps above in reverse order.

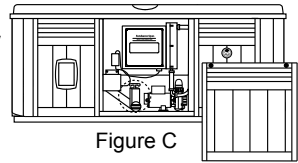

Figure C

13.3 Draining And Refilling

About every 3 to 6 months, you will should replace the hot tub's water. The frequency depends on a number of variables including the amount of use, attention paid to water quality maintenance, etc. You will know it is time for a change when you cannot control sudsing and/or you can no longer get the normal feel or sparkle to the water even though the key water balance measurements are all within the proper parameters.



CAUTION! READ THIS BEFORE DRAINING: To decrease damage to the hot tub's components, turn off power to the hot tub at the circuit breaker before draining it. Do not turn the power back on until your hot tub has been refilled. There are certain precautions to keep in mind when draining your hot tub. If it is extremely cold, and the hot tub is outdoors, freezing could occur in the lines or the equipment (see "Winterizing," page 66). On the other hand, if it is hot outdoors, do not leave the hot tub's surface exposed to direct sunlight for long periods.

Draining Procedures:

1. Turn off power to hot tub at breaker.
2. Locate the 3" gray drain valve cap on side of the hot tub cabinet. Unscrew drain valve cap to expose the underlying male garden hose fitting (Figures A-B).
3. Attach female garden hose end to drain fitting and route opposite end of garden hose away from hot tub (Figure B).
4. Pull outward on garden hose end at drain connection (approx. 3/8") to open drain valve and release water from hot tub (Figure C). Water drains at approximately 3 gallons per minute.
5. After hot tub has drained, close drain valve by pushing inward on garden hose end at drain connection until you feel it bottom out. Remove garden hose and install gray drain cap before refilling hot tub.

Figure A



Figure B

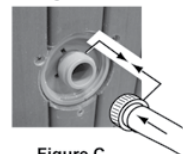
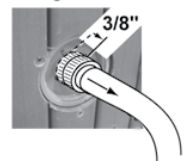

Figure C



Note: The gray drain cap cannot be installed until the drain valve is closed. Refer to "Hot Tub Fill Up Procedure" (page 17) for recommended filling instructions.

Draining Procedures (Quick Drain):

1. Turn off power to hot tub at the breaker.
2. Locate the two Quick Release Door buttons for the center cabinet, (Figure A). Press the buttons to release the panel from the spa frame. Gently pull the cabinet forward and off (Figure B). Place the panel in a safe location to prevent from damaging it.

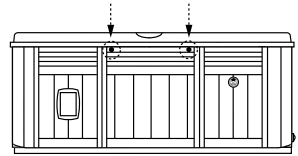

Figure A

Note: For the Maxxus and Aspen models the front panel must be unscrewed to be removed.

3. Locate the Quick Drain Valve. Unscrew drain valve cap (Figure C). Place the cap aside.
4. Screw in the adapter with hose that was included in the equipment bay, attach it to the quick drain (Figure D). Make sure to direct the hose to an area where the water will drain properly.

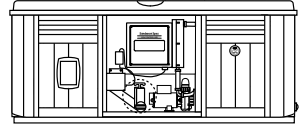

Figure B

5. Open the drain slice valve by sliding the handle to the side and pulling up.
6. After the hot tub has drained close the slice valve by pushing it downward and sliding the handle to the side. Remove the adapter and reinstall the Quick drain cap before refilling hot tub.

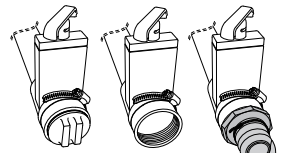

Figure C

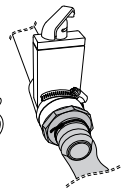

Figure D

13.4 Cleaning The Hot Tub Interior

To preserve the sheen of your hot tub's surface, it is crucial that you avoid using abrasive cleaners or cleaners which have adverse chemical effect on the surface. If you are not certain as to the suitability of a particular cleanser, consult your authorized Sundance Spas dealer. Regardless of the cleanser used, use extreme care to assure that no soap residue is left on the surface. This could cause severe sudsing when the hot tub is refilled.

13.5 Pillow Care

Remove and clean the headrest pillows as needed with soapy water using a cloth or soft-bristle brush. Always remove the pillows when adding chemical shock treatment to the spa water. The pillows can be returned to the spa when the sanitizer reading is stable as recommended on the inside cover of the manual.

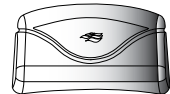

1

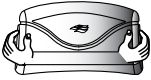

Place both hands on pillow with thumbs as shown.

2



Press inward with thumbs to curl pillow lip inward so you can grab it with fingertips.

3



Flex pillow lip inward 2-3" to get a good grip on the ends.

4

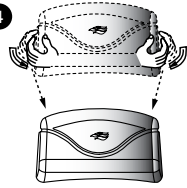

Gently pull outward on pillow to release mounting stud from receptacle on spa shell.

5

Wash pillow(s) in a mild detergent soap and warm water solution. Never machine wash your pillows or attempt to clean them with a cleaning agent!

6

To reinstall pillows: Simply align pillow over mounting stud receptacle, then gently push inward to snap in place.

13.6 Maintaining the Hot Tub Cabinet

The hot tub cabinet require little or no maintenance of any kind. To clean, wipe cabinet with a clean towel and mild detergent soap solution.



CAUTION: Never spray cabinet with a high pressure garden hose for any reason since this action may induce an electrical short in the hot tub's electrical equipment.

13.7 Vinyl Cover Care And Maintenance

Using the Sundance insulating spa cover anytime the spa is not in use will significantly reduce your operating costs, heat-up time and maintenance requirements. To prolong the life of the cover, handle it with care and clean it regularly. Below are the care instructions.

A. To Clean and Condition the Vinyl Cover

1. Use a garden hose to loosen debris and dirt.
2. Using a large sponge or a soft bristle brush, use diluted or mild soap and scrub the vinyl top. Rinse clean and do not allow soap to dry on cover. Do not use soap on the underside of the cover.
3. Please check with your Sundance Spa Dealer for recommended cover care and conditioning products. Condition using non-petroleum based conditioners to keep the vinyl supple and threads/stitching from drying out. Do not use solvents, abrasive cleaners or strong detergents. Do not use products that contain silicone or alcohol.

B. Additional Care and Maintenance Instructions:

1. Debris can accumulate on the spa cover. Removal of snow or other debris will help to avoid breakage of the foam cores.
2. Be sure to lock the cover straps to secure the cover from unwanted or accidental entry.

3. Do not place heavy objects on the vinyl.
4. Do not walk, sit or stand on the cover.
5. Do not drag or use the flaps/skirt or the cover lock straps to remove the cover.
6. Use only recommended cover lift systems.
7. Use only chemicals and cleaners recommended by Sundance Spas.
8. Remember to keep spa covered when not in use. Maintaining proper water levels assures efficient operation and efficient electrical usage.
9. Do not expose your spa to the sun for extended periods of time as UV rays can damage the interior surface.
10. Use caution when removing cover. Before removing cover, assure all locks have been released to avoid lock breakage and/or cover strap damage.

13.8 Winterizing

Your Sundance hot tub is designed to automatically protect itself against freezing when operating properly. During periods of severe freezing temperatures, you should check periodically to be certain that the electrical supply to the hot tub has not been interrupted. In extreme, bitter cold weather less than 32°F (0°C), program the circulation pump to run for 24 hours to prevent freezing.

If you do not intend to use your hot tub, or if there is a prolonged power outage during periods of severe freezing temperatures, **it is important that all water be removed from the hot tub and equipment to protect against damage from freezing.**

Expert winterization of your spa is highly recommended, contact your authorized Sundance Spas dealer. In emergency situations, damage can be minimized by taking the following steps:

CAUTION: TURN OFF POWER TO HOT TUB!
--

1. Follow the directions (Section 13.3) for draining the hot tub.
2. Turn the massage/diverter selector(s) to the middle combo position to allow the water in the plumbing lines to drain, page 50.
3. Turn the waterfall valve(s) to the open position to allow the water in the plumbing lines to drain, page 51.
4. As the water level drops below the seats, use whatever means necessary to get the water out of the recessed seating areas and into the footwell, such as a wet/dry vacuum.
5. Open all the air controls and leave them open until you resume use of the spa, page 51.
6. When the water level ceases to drop, use whatever means available to remove any remaining water from the footwell, such as a wet/dry vacuum.
7. Remove the equipment-side cabinet panels and locate the drain plugs in the front of each pump (Figures A and B, pages 13-14).

Remove these plugs to allow the water to drain out of the pumps and heater.

Note: Approximately 1 to 2 gallons will be released during this procedure. Use a wet/dry vacuum or other means to keep this from flooding the equipment compartment. Replace the drain plugs.

8. Loosen hose clamp at bottom of heater (Figures A and B, pages 13-14) and pull hose off of heater fitting (twist the hose back and forth while pulling downward). Tip hose down and allow to drain, then reinstall hose and clamp.
9. Loosen hose clamp at bottom of CLEARRAY® system and pull hose off of CLEARRAY fitting (twist the hose back and forth while pulling downward). Tip hose down and allow to drain, then reinstall hose and clamp. Remove the cover of the CLEARRAY system to access the UV bulb and quartz tube. Remove and store the UV bulb in a safe location. Remove and dry off the quartz tube then reinstall it. Depending on the length of time, consider replacing the UV bulb when you resume use of your hot tub.
10. Re-install cabinet side panels and cover hot tub so that no moisture can enter into it. Consult your Sundance Spas dealer if you have any questions regarding winter use or winterizing.

13.9 Restarting Your Hot Tub in Cold Weather

If you want to start up your hot tub after it has sat empty for a time in freezing temperatures, be aware that the water remaining in certain sections of the piping may still be frozen. This situation will block water flow preventing the hot tub from operating properly and possibly damaging the equipment. We recommend you consult your dealer for guidance before attempting to restart your hot tub under these conditions.

14.0 Water Quality Maintenance

To decrease the risk of contracting a waterborne illness (e.g. an infection, bacteria or virus) and/or respiratory ailments, maintain water quality within specified limits. This will enhance your enjoyment and prolong the life of the hot tub's equipment. Doing so requires regular attention because the water chemistry involved is a balance of several factors. Procrastination in regard to water maintenance will result in poor and potentially unhealthful conditions for soaking and even damage to your hot tub investment. For specific guidance on maintaining water quality, consult your Authorized Sundance Spas dealer who can recommend appropriate chemical products for sanitizing and maintaining your hot tub.

**WARNING: FAILURE TO MAINTAIN WATER QUALITY WILL:**

- Increase risk of contracting a waterborne illness (e.g. an infection bacteria or virus) and/or respiratory ailments.
- Damage the equipment, components and spa shell, which are not covered under the hot tub's warranty.

CAUTION: Never store hot tub chemicals inside the hot tub's equipment bay. The equipment bay may reach elevated temperatures, this is where high voltage electronic devices are located. This area is not intended for storage of any kind.

14.1 pH Control

pH is a measure of relative acidity or alkalinity of water and is measured on a scale of 0 to 14. The midpoint of 7 is said to be neutral, above which is alkaline and below which is acidic. In hot tub water, it is very important to maintain a slightly alkaline condition of 7.4 to 7.6 pH. Problems become proportionately severe the further outside of this range the water gets. A low pH will be corrosive to metals in the hot tub equipment. A high pH will cause minerals to deposit on the interior surface (scaling). In addition, the ability of the sanitation agents to keep the hot tub clean is severely affected as the pH moves beyond the ideal range. That is why almost all hot tub water test kits contain a measure for pH as well as sanitizer.

14.2 Sanitizing

To destroy bacteria and organic compounds in the hot tub water, a sanitizer must be used regularly. Your Sundance hot tub is equipped with the Brominator™, a special compartment built into the floating skimmer gate to hold the SunPurity™ mineral cartridge designed specifically for your hot tub or bromine tablets. By regulating the number of bromine tablets in the Brominator you can control the amount of bromine, which is actively working, in your hot tub water. A bromine residual of no less than 2.0 ppm is generally considered desirable. A two-part bromine system or granular chlorine (dichlor) are also acceptable sanitizers. When adding spa shock (chlorine or non-chlorine) or pH balancing chemicals, activate the jets pump(s) and leave the spa cover open for a minimum of 20 minutes. By doing this you will allow excess chemical vapors to exit the spa, protecting pillows and plastic knobs from chemical attack.



WARNING: RISK OF PERSONAL INJURY, DROWNING OR ENTRAPMENT!

Never leave your hot tub unattended for any reason while the cover is open and accessible, especially to small children and animals!

CAUTION: RISK OF PERSONAL INJURY OR SPA DAMAGE!

Never add chlorine tablets (trichlor) or acid to your hot tub for any reason! These chemical may damage components within your hot tub, burn or irritate your skin, create a rash, and void the manufacturer warranty for your spa.

14.3 CLEARARRAY® Water Purification System

Your new hot tub has our water purification system factory installed that will begin disinfecting your water instantly. CLEARARRAY Water Purification System is exclusive technology utilizing natural ultraviolet technology to sanitize your water, disinfecting bacteria, viruses, and algae in portable hot tubs. The ultraviolet light otherwise known as UV-C or germicidal light inactivates the microorganisms by disrupting the DNA so that it cannot reproduce and is considered lifeless. The ballast is the power supply for the purification system; it has two LED indicator lights the green indicating incoming power flow and the red indicating the system is properly working. CLEARARRAY is standard for all models.

Note: The CLEARARRAY System only runs when the circulation pump is running and shuts off when either jets pump is manually activated during spa use. The system will remain off for 5 minutes after both jets pumps time out or are manually turned off, then resume operations if the circulation pump is programmed to run.

After a year the bulb must be replaced. A message will appear on the LCD display when the time allotted has expired. In order to clear the “blb” message a new UV bulb needs to be installed and the timer must be reset (Sec. 12.8, page 58).

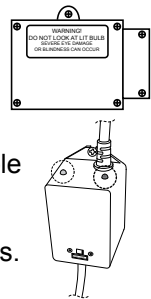

14.4 CLEARRAY® Bulb Replacement and Quartz Tube Maintenance

Important: It is **MANDATORY** that the UV bulb is replaced and the quartz tube be cleaned every 12 months to maintain optimum performance.

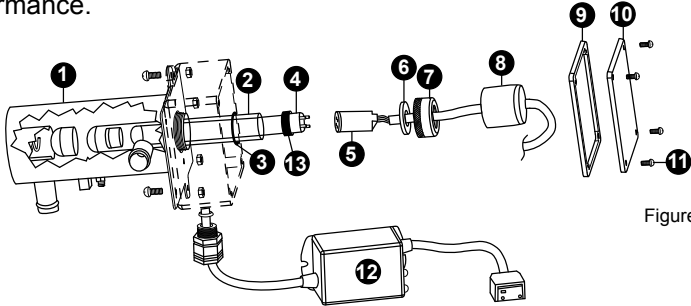

Figure 1



DANGER: TURN THE SPA BREAKER TO THE OFF POSITION!



DANGER: DRAIN THE SPA IF YOU ARE REPLACING OR CLEANING THE QUARTZ TUBE!



WARNING: ALLOW LAMP TO COOL DOWN PRIOR TO REMOVING FROM QUARTZ TUBE.



DANGER: NEVER LOOK AT THE LIT BULB. THIS CAN CAUSE SEVERE EYE DAMAGE OR BLINDNESS.

UV bulb replacement and quartz tube maintenance:

Note: Location of CLEARRAY System and connection may vary by model.

1. Turn the breaker to the spa OFF. DRAIN YOUR SPA.

Disconnect the CLEARRAY System from the controller, Figure 2.

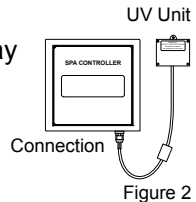

Figure 2

Note: If you are only replacing the UV bulb then the spa does not have to be drained. You will need to drain it if you are replacing or cleaning the quartz tube.



DANGER: NEVER REMOVE COVER WITHOUT FIRST TURNING OFF AT POWER SOURCE AND DRAINING THE SPA.

2. Once the UV bulb has cooled off remove the CLEARRAY System enclosure cover (10) and gasket (9) by removing the four screws (11).

Figure 3

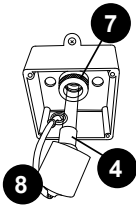

Figure 4

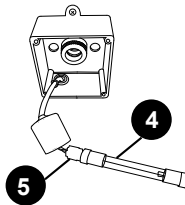
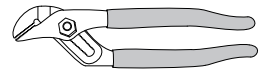

Figure 5



3. Remove the black bulb boot (8) by sliding it over the cable away from the quartz seal compression nut (7), Figure 3.
4. Slowly remove the UV bulb (4) out of the quartz tube.
5. Remove bulb socket (5) from the UV bulb (4), Figure 4.
6. Remove the quartz seal compression nut (7) by turning it **counterclockwise**, Figure 3. Use a pair of channel-lock pliers if needed, Figure 5. You will notice that there is a stainless steel compression washer (6) that slides over the quartz tube. Save the washer (6) for later use, Figure 6. There is also a black seal ring (13), grasp the black seal ring, slowly and carefully remove the quartz tube.
7. Now you are ready to clean or replace the quartz tube (2). For the cleaning of the quartz tube (2), follow steps 8 and 9 then proceed to step 10. For replacing of the quartz tube (2), skip steps 8 and 9 and proceed to step 10.
8. **Cleaning quartz tube:** Clean the quartz tube by wiping until clear using a paper towel or a dry cotton cloth. If needed a household tub and shower lime removal product can be used.

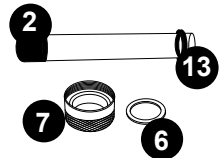

Figure 6



WARNING: Do not use abrasive cleaners as they can scratch the quartz tube surface.

9. Rinse the quartz tube with clean water to completely remove any cleaning products that were used in step 4.
10. **Replacing quartz tube:** You will notice that the new quartz tube does not have a black cushion on the domed end as the old quartz tube does. This is normal as the cushion was provided with the original quartz tube to protect it from breakage during transportation. Install the black seal ring (13) over the opened end of the quartz tube. Place the new quartz tube (2) into the water chamber (1) with the domed end first making sure it is inserted and seated inside the quartz end holder. Only a small portion will be exposed when it is seated correctly.
11. Reinstall the compression washer (6) over the open end of the quartz tube (2). Push it against the quartz black seal ring (13).
12. Reinstall and hand tighten the quartz seal compression nut (7) by turning it **clockwise**.
13. Refill your spa.

14. **System Test 1:** Assure there is no water dripping from the seal compression nut (7). If water is visible, STOP and tighten the compression nut (7) using a pair of channel lock pliers to a maximum of 1/4 turn. If that does not fix the leak, then repeat quartz tube maintenance process from step 1 through step 13. Make sure there is no water leaking before proceeding to step 15.
 15. **System Test 2:** Reconnect the CLEARRAY unit to the controller. Turn breaker back ON. Turn on the pump to circulate the water through the CLEARRAY System. Wait for 5 minutes and assure no water is dripping. If water is visible, STOP, fix the leak by repeating quartz tube maintenance process from step 1 through step 14. **Make sure there is no water visible and turn the pump and breaker OFF and disconnect the CLEARRAY unit to the controller BEFORE proceeding to step 16.**
 16. Reconnect the bulb socket (5) to the new UV bulb (4) make sure you use the latex glove provided when handling the UV bulb.
- Note:** Align pins on UV bulb (4) to the receptacle holes on the bulb socket (5) before inserting the pins completely into socket holes. Failure to do so will damage the UV bulb.



WARNING: DO NOT TOUCH THE NEW UV BULB WITH YOUR BARE HAND. Oil on your skin will cause hot spot on the UV bulb and shorten the life of your UV bulb. Use the provided latex glove to handle the UV bulb.

17. Slide the new UV bulb (4) back inside the quartz tube, Figure 3.
18. Reinstall the black bulb boot (8) back over the quartz seal compression nut (7).
19. Reinstall the enclosure cover (10) with gasket (9) and secure with the screws.
20. Reconnect the CLEARRAY System to the controller and turn on the power to the spa.
21. Properly dispose of the old UV bulb.



WARNING: This CLEARRAY System includes a UV bulb, which contains mercury. Dispose of the bulb in accordance with disposal laws. See www.lamprecycle.org.

22. Once power is activated you can check the ballast (12), Figure 7, to see if the CLEARRAY System is functioning. A solid green light indicates that the CLEARRAY System is being provided power and should always be on. A solid red light indicates that UV bulb is activated.

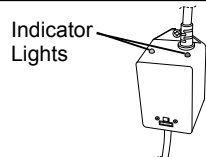

Figure 7

14.5 Other Additives

Many other additives are available for your hot tub. Some are necessary to compensate for out-of-balance water, some aid in cosmetic water treatment and others simply alter the feel or smell of the water. Your Authorized Sundance Spas dealer can advise you on the use of these additives.

14.6 Handrail Maintenance

The handrails in your Sundance hot tub are manufactured from a high quality 316 stainless steel alloy. Many people are familiar with the term "stainless steel" and are surprised to learn that it does indeed rust and corrode in the presence of chloride salts, free chlorine, or sulfide gasses. The bad news is the environments that produce these elements are ocean spray, salted highways, chemical treatments added to swimming pools and hot tubs, and ground water in numerous coastal areas. The good news is with proper care, your hot tub's handrails can maintain their original finish.

If your stainless handrails shows signs of rusting you should:

- Wash with fresh water (a good detergent won't hurt).
- Clean with a good car chrome polish.
- Wax with an automotive or fiberglass wax.

You should never:

- Clean with chlorinated cleaners or scouring powders.
- Use sand paper, "Scotch Brite," Brillo pads, or similar abrasive products.
- Clean with muratic or hydrochloric acids. Vinegar is ok, but it won't do much to remove rust.

15.0 Troubleshooting - Display Messages

There are a number of unique functions designed into your Sundance hot tub to protect it from damage and/or to aid in troubleshooting. The indicator light located on the front cabinet panel of the spa is an early detection system that will notify you when the spa needs immediate attention. A solid white light indicates that all operations are normal. A solid red light indicates that immediate attention is required to clear or fix an error code. Following is a listing of all the possible messages along with their meanings.



Always insist on genuine Sundance replacement parts.

Error	Logo Light	Error	Logo Light
OH	Red	----	Red
COOL	White	SN1	Red
FLO	Red	SN3	Red
HOT	White	FLO2	Red
ICE	White	ICE2	Red
PNL	Red	BLB	Red

MESSAGE MEANING

OH



WARNING: RISK OF HYPERTHERMIA (OVER-HEATING) CAUSING SEVERE INJURY, BURNS, OR WELTS.

Overheat Protection (Heater is deactivated, filter/circulation pump is activated). Water temperature is above acceptable limits. **DO NOT ENTER THE WATER!** Remove hot tub cover to speed cooling. See “Water is too hot” (page 77). If condition persists, contact your Sundance Spas dealer or qualified service technician.

COOL

If the hot tub water is more than -7°C cooler than the temperature setpoint, jets pump #1 and heater will automatically activate to provide freeze protection. The hot tub will stay in this mode until the water temperature reaches 15 degrees below the set temperature. No corrective action is necessary.

FLO* FLOW SWITCH (Heater is deactivated. The filter/ circulation may also be deactivated). Proper flow of water is inhibited or a flow switch has malfunctioned. Check for proper water level and for clogged filter (pages 60-62). Contact your Sundance Spas dealer or qualified service technician.

***Note:** This message can also appear if the pump has not regained prime after the hot tub has been drained and refilled. If you suspect that this is the case, see the instructions on page 77 under “pump does not operate and icon does.”

HOT Circuit board temperature has exceeded acceptable limit. This message will disappear when the circuit board temperature drops below acceptable limit. If condition persists, provide shade for equipment side of hot tub.

ICE FREEZE PROTECTION
A potential freeze condition has been detected. No action is required. Jets pump(s) operate until the hot tub is out of danger.

Note: This error commonly occurs when the hot tub is first filled because tap water is often very cold.

PF Power failure. Power fluctuation in the secondary power line is causing the DC voltage to be low. Try to reset power to spa. Should the power level return to normal, the PF error will reset itself. If the error returns, contact your Sundance Spas dealer or qualified service technician.

PnL Communication between the control panel and/or remote control panel and circuit board is faulty. Contact your Sundance Spas dealer or qualified service technician.



WARNING: RISK OF HYPERTHERMIA (OVER-HEATING) CAUSING SEVERE INJURY, BURNS, OR WELTS.

“WATCHDOG” (hot tub is deactivated). Water temperature is above acceptable limits. **DO NOT ENTER THE WATER!** Remove hot tub cover to speed cooling. A problem has been detected which could cause damage to the hot tub or its components. Contact your Sundance Spas dealer or qualified service technician.

5n1

OPEN SENSOR (heater disabled) or SHORTED SENSOR (hot tub is deactivated)

The high-limit temperature sensor is non-functional. This must be repaired only by an Sundance Spas dealer or qualified service technician.

5n3

OPEN or SHORTED SENSOR (heater disabled)

The main temperature sensor is non-functional. This must be repaired only by an Sundance Spas dealer or qualified service technician.

FLO2
ICE2

CLOSED or SHORTED FLOW SWITCH ON SYSTEM STARTUP (system disabled) Flow switch is non-functional. This must be repaired only by an Sundance Spas dealer or qualified service technician.

blb

UV bulb needs to be replaced. The message will flash between “blb” and the water temperature. The countdown timer for the UV bulb needs to be reset (Section 12.8, page 58). A new UV bulb can be purchased from a local Sundance Spas dealer.

16.0 Troubleshooting - Procedures

In the unlikely event your hot tub is not working the way you believe it should, please first review all the installation and operating instructions in this manual and check the message on the panel display; second, if you are still not satisfied it is working properly, please follow the appropriate troubleshooting instructions.

PROBLEM

None of the components operate (i.e. pump, blower, light)

PROCEDURE

Check the control panel lights.

1. If there are letters or symbols displayed on the screen, refer to the previous section to determine meaning and action required.
2. If nothing appears on the screen:
 - A. Check the household circuit breaker.
 - B. Contact you Sundance Spas dealer or qualified service technician.

- Pump does not operate and icon does
- Depress JETS Button.
1. If no sound is detected or if a buzzing sound is detected, turn off power to the spa and contact your authorized dealer or qualified service technician.
 2. If motor operates, but now water flows to jets:
 - A. Pump may not be properly primed. See instructions below.
 - B. Contact your Sundance Spas dealer or qualified service technician.

Pump Priming Instructions:

This method must be used for the jets pumps because these pumps are not connected to the main filter system in any way.

1. Turn off the power to the spa.
2. Remove the handle from the massage selector supplied by the pump you are priming.
3. Loosen the massage selector's cap slightly (counterclockwise), listening for the air to seep out.
4. Tighten the cap finger tight, replace the handle, and turn the spa's power back on.

CAUTION: If freezing conditions exist and pump is not operational, take measures to protect the system from freeze damage. See Section titled "Winterizing," page 66.

PROBLEM	PROCEDURE
Poor jet action (Sections 9.4-9.25, pages 24-45)	<ol style="list-style-type: none"> 1. Make certain the jets pump is turned on. 2. Check position of massage selectors. 3. Open air control for selected jet system. 4. Check for adequate water level. 5. Check for dirty filter (pages 60-62).
Water is too hot	<ol style="list-style-type: none"> 1. Reduce thermostat setting (page 18). 2. Switch hot tub to "Economy" mode to turn heater on only during programmed filter cycles (page 54).
No heat	<ol style="list-style-type: none"> 1. Check thermostat setting. 2. Keep the cover in place while heating. 3. If "heater on" indicator is lit but no temperature rise is experienced after a reasonable period of time, contact your Sundance Spas dealer or qualified service technician.

Filter/
circulation
pump off

1. Verify filter/circulation pump is programmed to run 8 hours a day (page 54).
2. Filter/circulation pump cycle canceled by power interruption. Wait 24 hours for hot tub to reset or press select button for manual activation.
3. Hot tub water is warmer than 95°F (35°C) and two degrees warmer than the set temperature. The “Summer Logic” safety feature has activated. See note on page 55 for details.

Should checking the above steps fail to correct the problem, please call your authorized dealer so that he may arrange service.

Sundance builds the best hot tubs in the industry. Nonetheless, we are always striving to improve the quality and features of our products. Your input as a Sundance hot tub owner is a cherished part of this process. If you have any comments or suggestions, or if you wish to be informed on any new products for your hot tub, please write to us.

CONGRATULATIONS on your good taste and welcome to the happiest and most relaxed family in the world!

17.0 North American 60 Hz Electrical Wiring Diagram

17.1 North American 60 Hz Maxxus/Aspen Electrical Wiring Diagram

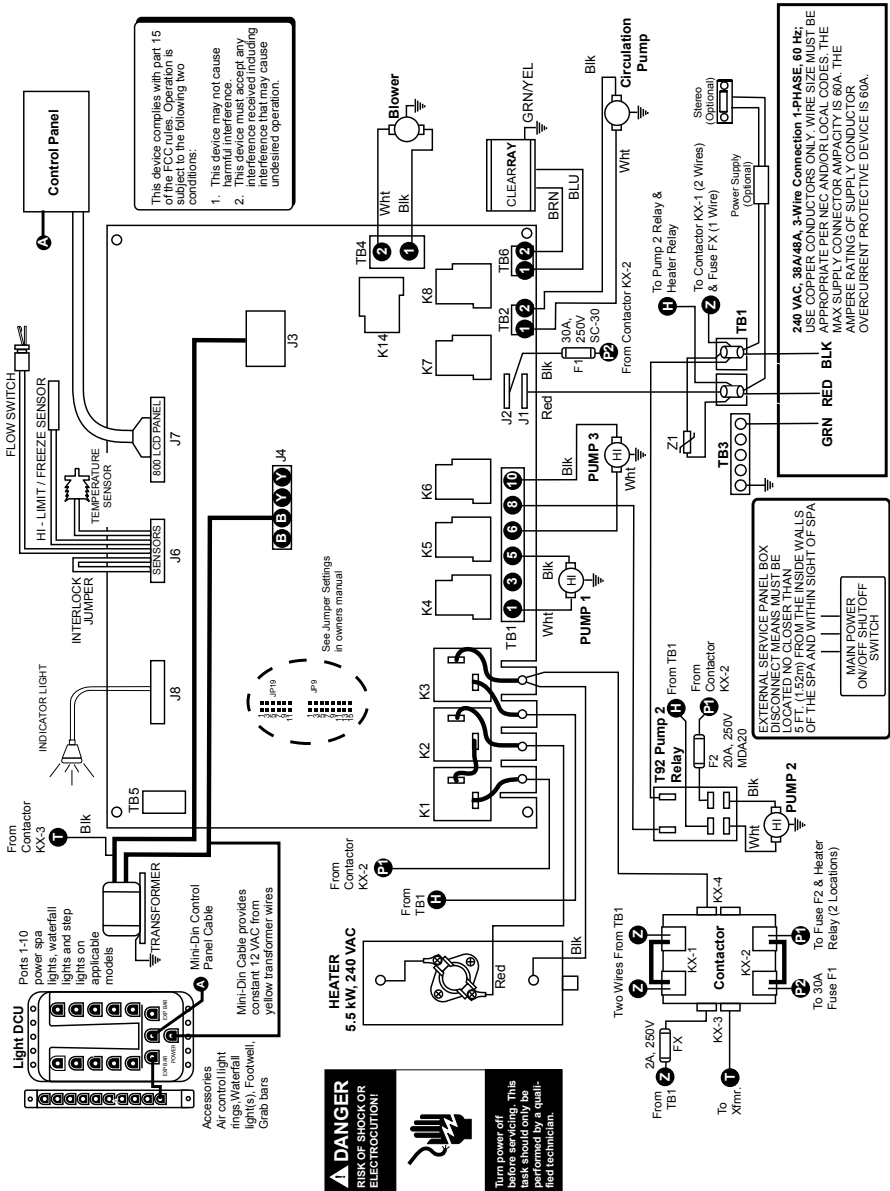

17.2 North American 60 Hz Altamar/Cameo/Capri/Majesta/Marin Electrical Wiring Diagram

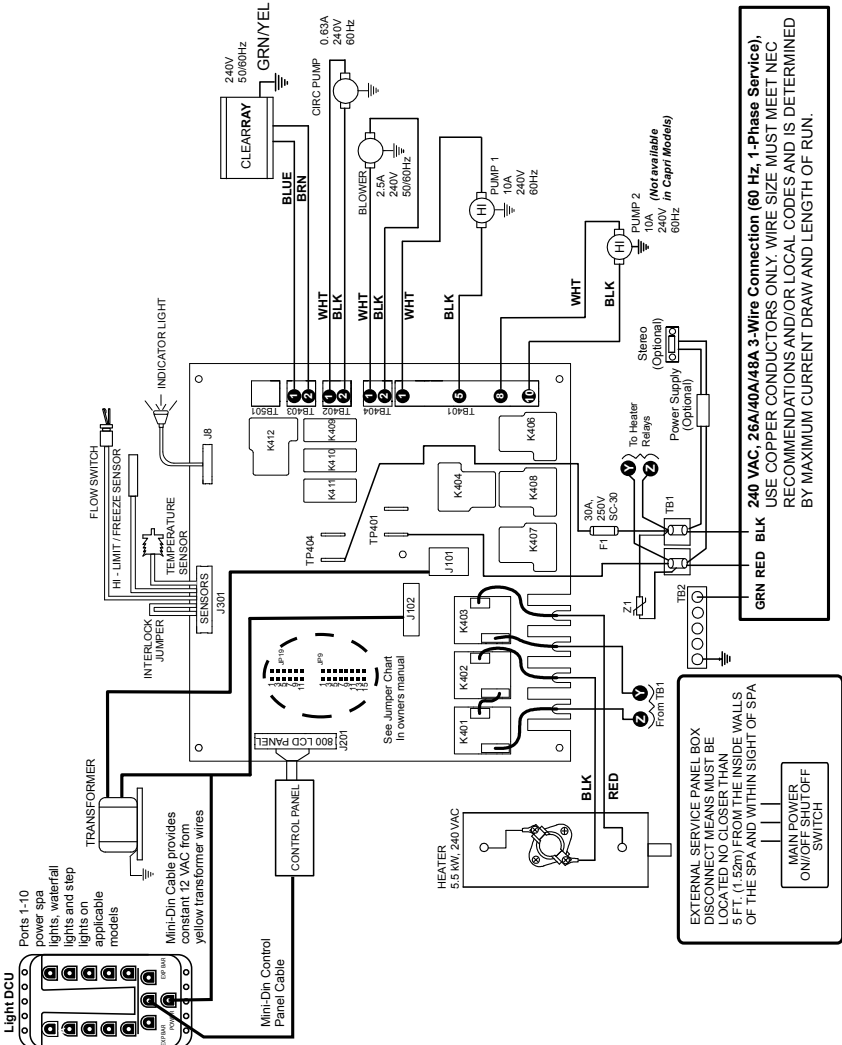

⚠ DANGER
RISK OF SHOCK OR ELECTROCUTION!

Turn power off before servicing. This is a safety precaution and should be performed by a qualified technician.

18.0 Export 50 Hz Electrical Wiring Diagram

18.1 Export 50 Hz Maxxus/Aspen Electrical Wiring Diagram

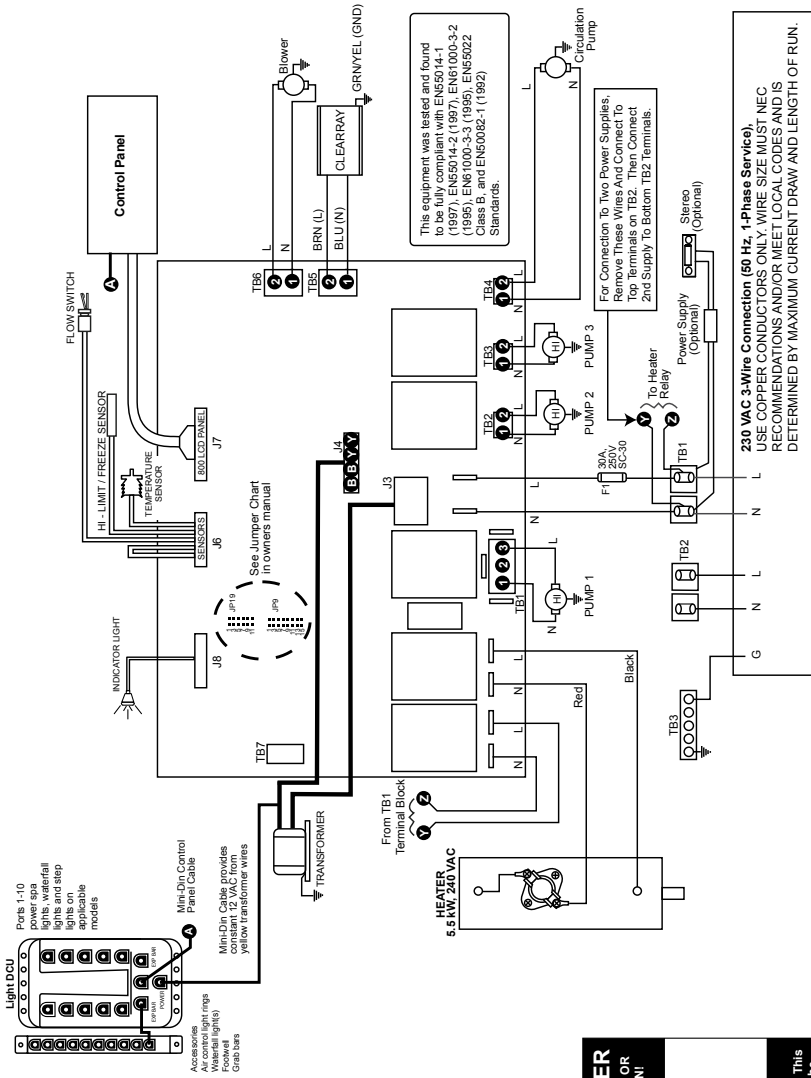

⚠ DANGER
 RISK OF SHOCK OR
 ELECTROCUTION!

Turn power off before servicing. This task should only be performed by a qualified technician.

18.2 Export 50 Hz Altamar/Cameo/Capri/Majesta/Marin Electrical Wiring Diagram

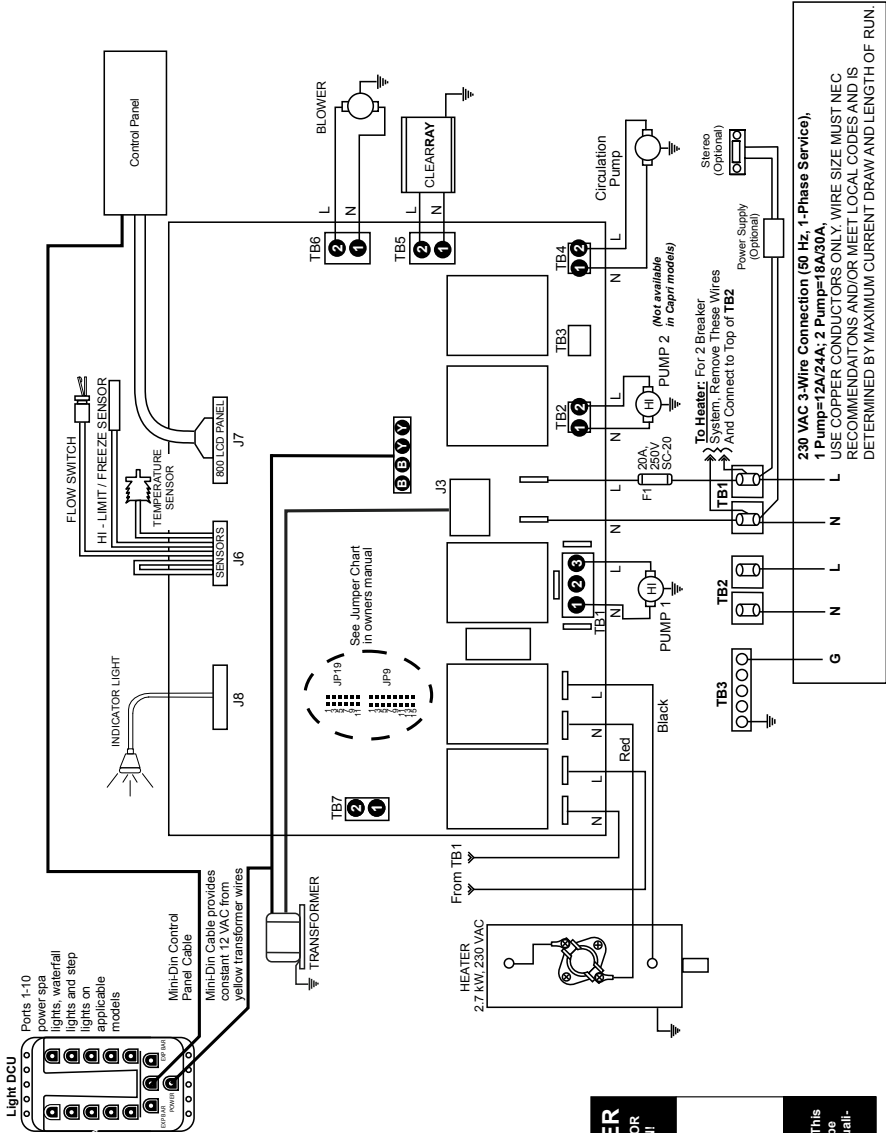

⚠ DANGER RISK OF SHOCK OR ELECTROCUTION!

Turn power off before servicing. This task should only be performed by a qualified technician.

19.0 Circuit Board Pin Assignments

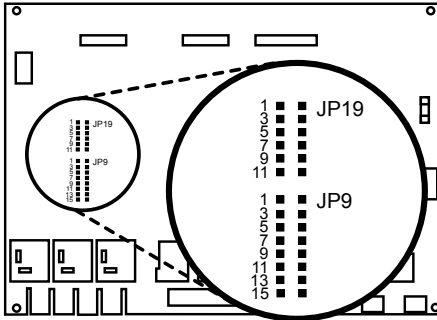

JP19-1	On = °C Off = °F
JP19-3	On = 50 Hz Off = 60 Hz
JP19-5	On = Enables the logic for the Multi-Color LED Light Off = Enables the logic for the Incandescent Light
JP19-7	Not used
JP19-9	Not used
JP19-11	Not used
JP9-1	On = Enables the trouble log Off = Disables the trouble log
JP9-3	Not Used
JP9-5	Not Used
JP9-7	On = Enables 60A logic (Allows 2 jets pumps and the heater to operate at the same time) Off = Enables 50A logic (Forces the heater to turn off when more than 1 jets pump is running)
JP9-9	On = 2 or 3-Pump logic Off = 1 Pump logic
JP9-11	On = Enables 40A logic (Forces heater to turn off in any jets pump is running in high speed or if the blower is on Off = Disables 40A logic
JP9-13	Not Used
JP9-15	Not Used

20.0 Typical Hot Tub Wiring Diagrams A-B (North American 60 Hz Models Only)

⚠ DANGER
RISK OF SHOCK OR ELECTROCUTION!



Turn power off before servicing. This task should only be performed by a qualified technician.

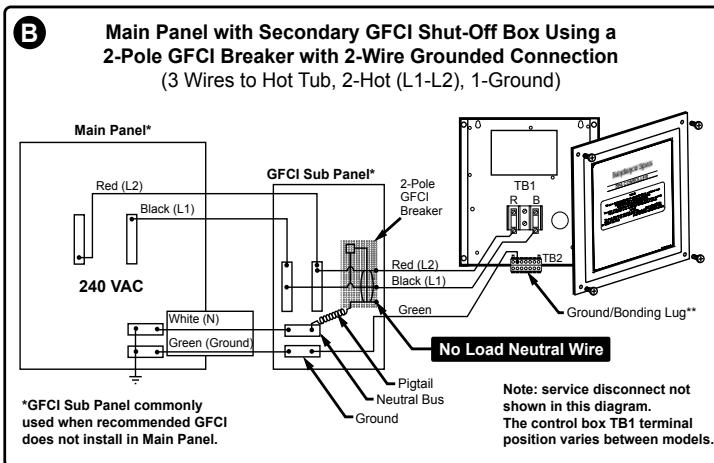
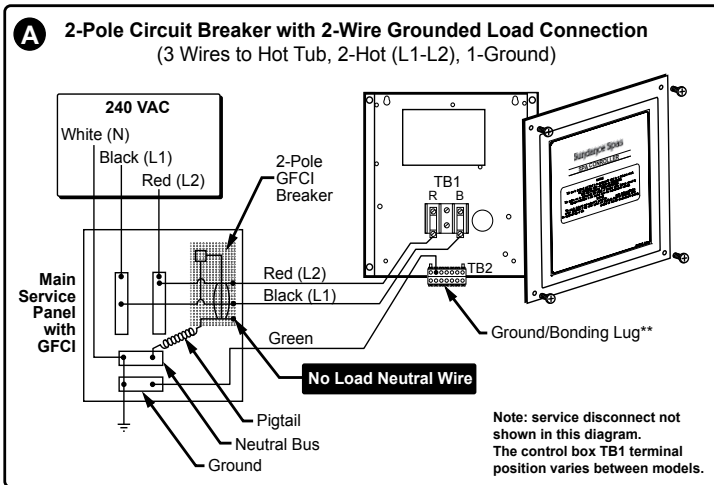

21.0 Optional BLUEWAVE® Spa Stereo System

To start enjoying your new stereo receiver, please read the following operation instructions in their entirety.

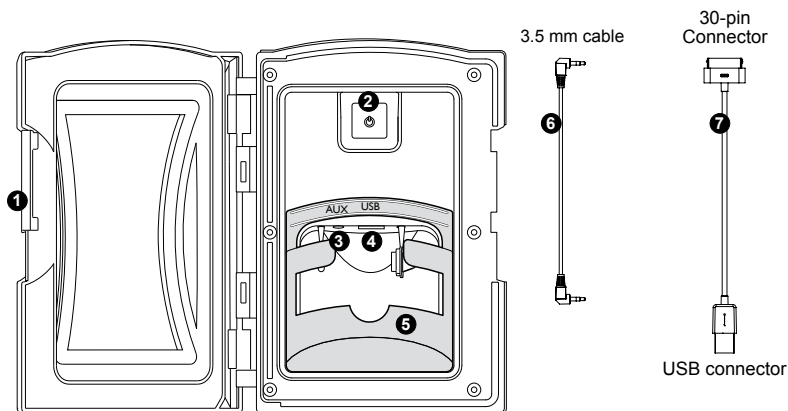

1. **Media Locker Handle**
Slide the handle to lock and unlock the protective door.
2. **Power Button**
Press power button once to turn “ON” stereo system. Press a second time to place the stereo in “Standby” mode and the red light will remain illuminated.
3. **Auxiliary Input Jack Connector**
Allows you to connect an auxiliary device by using a 3.5 mm cable.
4. **Universal Serial Bus (USB) Device Connector**
Allows you to connect your device via a USB port and a USB cable compatible with your device.
5. **Auxiliary Device Holding Base**
The removable base securely holds the Auxiliary device, such as an iPod/MP3/iPhone, in place. It can be removed for larger devices.
6. **3.5 mm Cable (purchased separately)**
Use this cable to connect your Auxiliary or MP3 device to the stereo via the “AUX” connection.
7. **Apple 30-pin to USB Cable (purchased separately)**
Use this cable to connect your compatible iPod, iPhone or MP3 device to the stereo via the “USB” connection.



WARNING: RISK OF ELECTRICAL SHOCK HAZARD EXISTS AND EQUIPMENT DAMAGE!

Never install or remove electrical devices (e.g. Apple device/MP3/USB/AUX/Bluetooth) while hands are wet or while sitting partially or fully immersed in the spa!

CAUTION: Never leave electrical devices in the Media Locker when spa is not in use to prevent damage from outdoor elements! Never spray Media Locker with a pressurized water hose for any reason! Damage to the device or spa stereo system caused by water intrusion is not covered under the manufacturer's warranty! Damage to Media Locker port or electrical devices due to excessive force or improper alignment during installation or removal from Media Locker is not covered under warranty.

21.1 Pairing the Remote and Stereo

In order for the remote to operate the stereo, you need to pair them using the following method:

1. Make sure the stereo unit is in "Standby" mode. LED power light will be red, Figure A.
2. Press any button on the remote to turn it ON. The remote LCD display will read "No Link."
3. Press and hold the "Mode" button on the remote (Figure B). At the same time, press and hold the power button on the stereo for 2 seconds (Figure A).
4. The remote LCD display will read "Welcome," "Load" and "Radio" if the pairing sequence was successful.

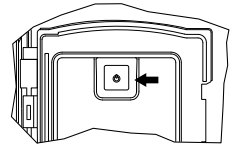

Figure A

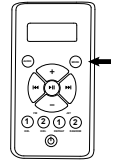

Figure B

21.2 Audio Settings

The Audio button, Figure C, provides access to many of the stereo's settings. By continually pressing the Audio button you can scroll and adjust the following functions: BAS-TRE-BAL-FAD-DSP-AREA-LOUD-DX-STEREO (respectively).

Note: You can adjust the settings by pressing the Audio button, making your adjustments and pressing the Audio button to go the next feature. If you exit the setting menus continually press the Audio button until you reach the setting you would like to adjust.

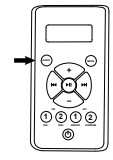

Figure C

1. **Bass Setting:** Press the Audio button once to access the bass setting. The LCD display will change to "BAS 0," Figure D. Press the Up button to adjust the setting to a maximum of +5. Press the Down button to adjust the setting down to -5.

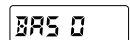

Figure D

Note: The default setting is "0." This feature is disabled when a "Digital Sound Processor" (DSP) setting is active such as "Rock," "Classic," or "Pop."

2. **Treble Setting:** Press the Audio button 2 times to access the treble setting. The LCD display will change to "TRE 0," Figure E. Press the Up button to adjust the setting to a maximum of +5. Press the Down button to adjust the setting down to -5.

Figure E

Note: The default setting is "0." This feature is disabled when a "Digital Sound Processor" (DSP) setting is active such as "Rock," "Classic," or "Pop."

3. **Balance Setting:** Press the Audio button 3 times to access the balance setting. The LCD display will change to "BAL L=R," Figure F. Press the Up button to adjust the setting to a maximum of 10R (only the right side speakers will have volume). Press the Down button to adjust the setting down to 10L (only the left side speakers will have volume).

Figure F

4. **Fade Setting:** Press the Audio button 4 times to access the fade setting. The LCD display will change to "FAD F=R," Figure G. Press the Up button to adjust the setting to a maximum of 10F (only the front speakers will have volume). Press the Down button to adjust the setting down to 10R (only the rear speakers will have volume).

Figure G

5. **Digital Sound Processor (DSP) Setting:** Press the Audio button 5 times to access the DSP setting. The LCD display will change to "DSP OFF," Figure H. Press the Up button to select one of the preset settings such as Rock, Classic or Pop. If a preset setting is selected a small icon will appear on the LCD display, Figure I.

Figure H

Figure I

6. **Area Setting:** Press the Audio button 6 times to access the Area setting. The LCD display will change to "AREA USA," Figure J. Press the Up button to select either USA or EUR setting.

Figure J

7. **Loud Setting:** Press the Audio button 7 times to access the Loud setting. The LCD display will change to "LOUD OFF," Figure K. Press the Up button to select either OFF or ON.

Figure K

8. **Distant Setting:** Press the Audio button 8 times to access the Distant setting. The LCD display will change to "DX," Figure L. Press the Up button to select either Distant (DX) or Local for station frequency. The "LOCAL" setting allows for better FM reception when a local station is too strong. Leave the setting to "DX" if this condition does not exist.

Figure L

9. **Stereo Setting:** Press the Audio button 9 times to access the Stereo setting. The LCD display will change to “STEREO,” Figure M. Press the Up button to select either Stereo or Mono.



Figure M

21.3 Wireless Remote Control Functions

A wireless radio frequency (RF) remote control is supplied on all spas with the optional audio system. This remote provides control of the radio and over some media device functions.

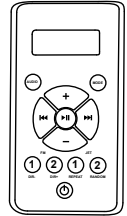

A. External Media Device Playback

The supplied remote control provides no control over external Auxiliary player operation except for volume control and source selection. All external Auxiliary playback operations are performed solely by the Auxiliary player.

Button	Operation
	Power Button: Press once to turn remote “ON” (remote LCD display will read “No Link”; Press a second time to turn stereo “ON” (remote LCD display will read “Welcome”; Press a third time to place the stereo in “Standby” mode.
	Audio Button: Allows access to most of the stereo sound functions. Press continuously to scroll through the following settings: Bas-Tre-Bal-Fad-DSP-Area-Loud-DX-Stereo.
	Mode Button: Press continuously to switch between “RADIO,” “USB,” and “AUX IN” modes. “BT AUDIO” appears when a Bluetooth device is paired with the stereo.
	Volume Up Button: Used to increase volume between 0 to 30.
	Volume Down Button: Used to decrease volume between 30 to 0.

Button	Device Mode (USB)	Radio Mode
	Play/Pause Button: Press to pause track, press again to resume playing	Mute Button: Press to mute sound, press again to reactivate sound
	Track Down Button: Press to rewind tracks	Seek Down Button: Seeks down for stations
	Track Up Button: Press to move forward tracks	Seek Forward Button: Seeks forward for stations
	Press the button to change music folders	Preset 1: Press to access a preset station

<p>② DIR +</p>	<p>Press the button to change music folders</p>	<p>Preset 2: Press to access a preset station</p>
<p>① REPEAT</p>	<p>Apple Device: Press once to turn feature on. Press again to repeat entire album. Press again to turn off USB Mode: Press once to turn on. Press again to turn off</p>	<p>Press once: pump 1 on Press again: pump 1 off</p>
<p>② RANDOM</p>	<p>Press to play songs in a random order</p>	<p>Press once: jets pump 2 on Press again: jets pump 2 off Press once: pump 2 on Press a second time: pump 3 on Press a third time: pump 2 off Press a fourth time: pump 3 off</p>

21.4 Electronic Device Connections and Functions

IMPORTANT REMOTE NOTICE:

- If stereo unit is “ON” (blue light is illuminated on the stereo power button) then press the power button on the remote once.
- If stereo unit is in “Standby” (red light is illuminated on the stereo power button) then press the power button on the remote once to activate the remote (remote LCD display will read “NO LINK”). Press the button again to activate the stereo unit (remote LCD display will read “WELCOME”).

A. Operating the Radio:

1. Turn power “ON” to the stereo unit. Press the power button on the remote. 
2. The LCD screen on the remote will display the following: “Welcome,” “Load,” “Radio” and the station number, Figure A.
3. You can use the seek button to search for frequencies.
4. You can save up to 2 stations as presets. Follow the steps below to set a station:
 - a. Find a station you want to save.
 - b. Press and hold one of the two preset buttons. The station preset number (1 or 2) on the display will quickly flash to confirm the setting. To set the additional stations, conduct this step again.

Figure A

B. Connecting Your Apple device/MP3 Player Using the USB:

1. Locate the USB port in the stereo locker (Figure B).
2. Use a 30-pin cable (purchased separately) for compatible devices (Figure C) or a cable provided with your device.
3. Connect the USB end of the cable into the USB connection on stereo.
4. Connect the 30-pin end of the cable to the Apple device/MP3 Player (purchased separately), Figure D.
5. After connecting the cable to both devices, set the player into the rubber holding base, Figure E.

Note: This also charges most compatible Apple devices when connected.

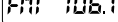
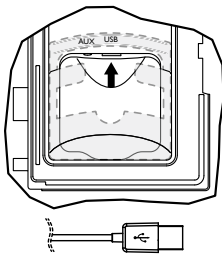

Figure B



Figure C
(purchased separately)

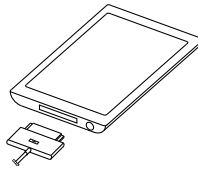

Figure D
(device purchased separately)

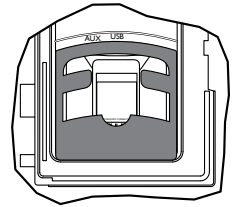

Figure E



CAUTION: RISK OF ELECTRICAL SHOCK OR EQUIPMENT DAMAGE!

Never install, remove or operate any electrical device (e.g. Apple device/MP3/USB/AUX/Bluetooth) while hands are wet or while sitting partially or fully immersed in the spa!

Note: The DRM (Digital Rights Management) Files cannot be played on this deck. Personal files (MP3, WMA, iTunes or AAC) can be played as long as they are not DRM encrypted.

C. Operating Your USB/MP3/Apple device

1. Turn power "ON" to the stereo unit. Turn power "ON" to the remote.
2. The LCD screen on the remote will display the following: "Welcome," "USB," "Load," "Apple" (final display will vary depending on the device connected). All functions are performed through the remote.
3. While the music is playing the remote screen will display and continually scroll through the following: Artist, Album, Song and Track information.
4. For operational functions refer to the "External Media Device Playback" section.

D. Operating the USB drive:

1. Plug in your USB device into the “USB” connection on the stereo, Figure A.
2. Turn power ON to the stereo unit and the stereo remote.
3. The LCD screen on the remote will display the following: “Welcome,” “USB,” “Load,” “TOL XX” (final display will vary depending on the whether the USB holds folders or files). All functions are performed through the remote.
4. While the music is playing the remote screen will display and continually scroll through the following: Title, Song, Artist, Album, Dir, Music and Track information.
5. For operational functions refer to the “External Media Device Playback” section.

E. Connecting Your Auxiliary Player Using the 3.5 mm Cable:

1. Plug one end of the cable to “Aux” connection (purchased separately) to the stereo, Figure F.
2. Plug the other end of the cable into the headphone jack connection on the iPod/MP3 Player.
3. Press the Mode button on the remote to “AUX IN.”
4. All playback operations are conducted via the Auxiliary Player. The stereo remote functions do not work on the external Auxiliary Player (except volume control).

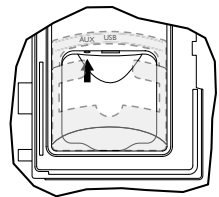

Figure F

F. Connecting Your Bluetooth Device:

1. Turn power ON to the stereo unit.
2. From your Bluetooth device, make sure the Bluetooth setting is ON.
3. Follow the pairing instructions for your Bluetooth device and connect to the “BLUEWAVE” device that appears on your screen.
4. If asked for a password, enter the code “0000.”
5. The remote LCD screen will display, “BT AUDIO” if the process was successful.

G. Operating Your Bluetooth Device:

1. Press the seek up or down buttons to scroll through the tracks (on the remote).
2. Press the volume up or down buttons to adjust volume level between 0 to 30 (on the remote).
3. Any other playback operations are conducted via the Bluetooth device.



CAUTION: RISK OF ELECTRICAL SHOCK OR EQUIPMENT DAMAGE!

Never install, remove or operate any electrical device (e.g. Apple device/MP3/USB/AUX/Bluetooth) while hands are wet or while sitting partially or fully immersed in the spa!

21.5 Wireless Remote Battery Replacement Procedure

1. Turn the remote unit over and locate the battery door (Figure A).

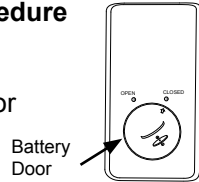

Fig. A

2. Rotate the battery door, with a coin, counterclockwise to the Open position (Figure B). When the door is unlocked it will pop up slightly.

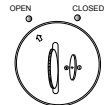

Fig. B

3. Remove battery door by lifting the door upward (Figure C).

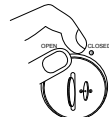

Fig. C

4. Replace battery using an equivalent (Figure D).

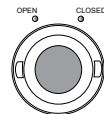

Fig. D

5. Reinstall the battery cover, using the coin rotate the door to the Close position (Figure E).



Fig. E

Note: Remote unit is water resistant not waterproof. Although it is designed for use while in the spa, it should never be left in the spa while the cover is on and spa is not in use. The remote should be stored in a dry location such as the stereo remote pouch (if applicable) located on the outside of the spa cover or within your home. Extreme weather can affect the remote control battery. In extreme hot or cold environments store the remote control indoors to prolong battery life.

21.6 BLUEWAVE Spa Stereo System Specifications



Power supply 10.7-14.4V DC

Tuner

FM radio sensitivity 8uV

FM radio reception Stereo

21.7 Stereo Cautions

1.  **“CAUTION** - Risk of Electric Shock. Do not leave compartment door open.”
2.  **“CAUTION** - Risk of Electric Shock. Replace components only with identical components.”
3. “Do not operate the audio/video controls while inside in the spa.”
4.  **“WARNING** - Risk of Electrocution. Do not connect any auxiliary components (for example cables, additional speakers, headphones, additional audio/video components, etc.) to the system.”
5. These units are not provided with an outdoor antennae; when provided, it should be installed in accordance with Article 810 of the National Electrical Code, ANSI/NFPA 70.
6. Do not service this product yourself as opening or removing covers may expose you to dangerous voltage or other risk of injury. Refer all servicing to qualified service personnel.
7. When the power supply connections or power supply cord(s) are damaged; if water is entering the audio/video compartment or any electrical equipment compartment area; if the protective shields or barriers are showing signs of deterioration; or if there are signs of other potential damage to the unit, turn off the unit and refer servicing to a qualified service personnel.
8. This unit should be subjected to periodic routine maintenance (for example, once every 3 months) to make sure that the unit is operating properly.



